

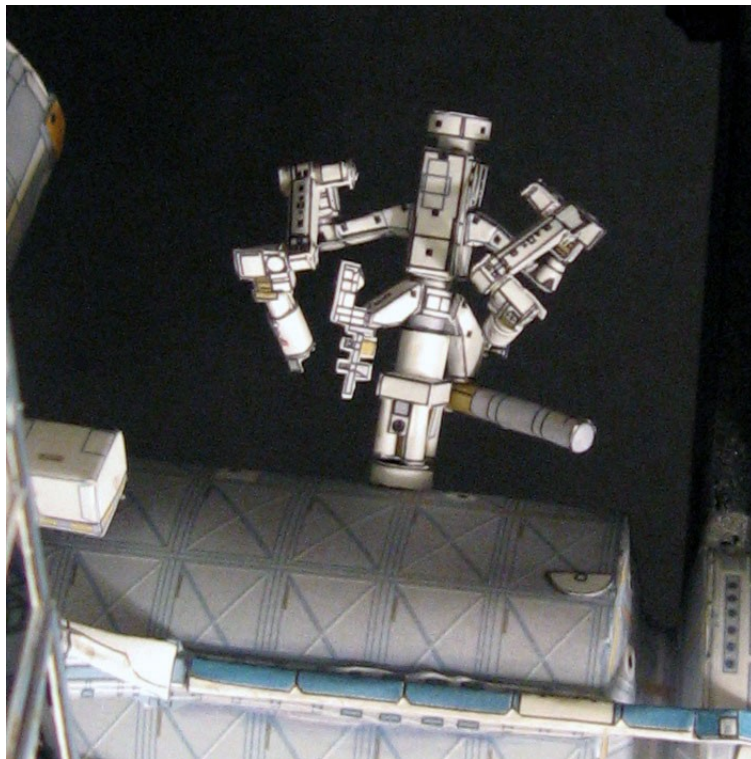

© 2013

DEXTRE 1:100 scale model Assembly Manual

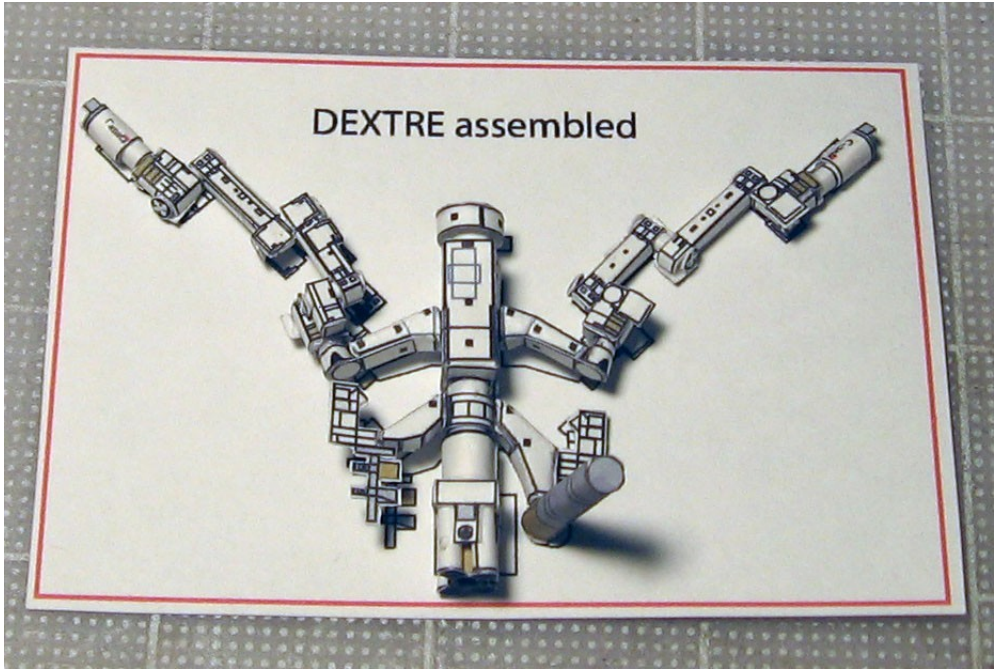



Building the Body

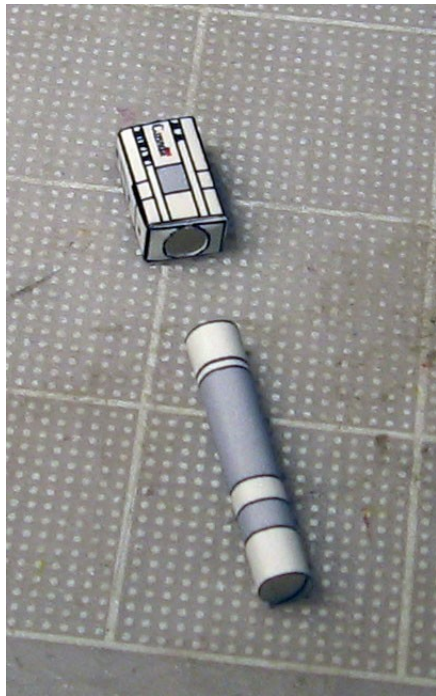
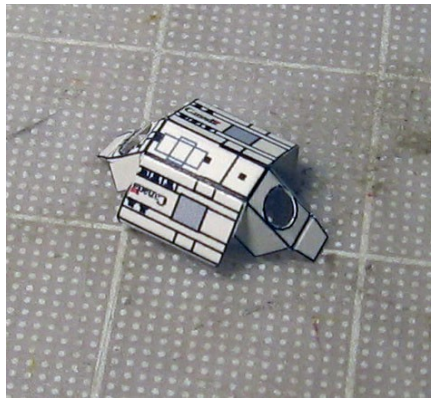
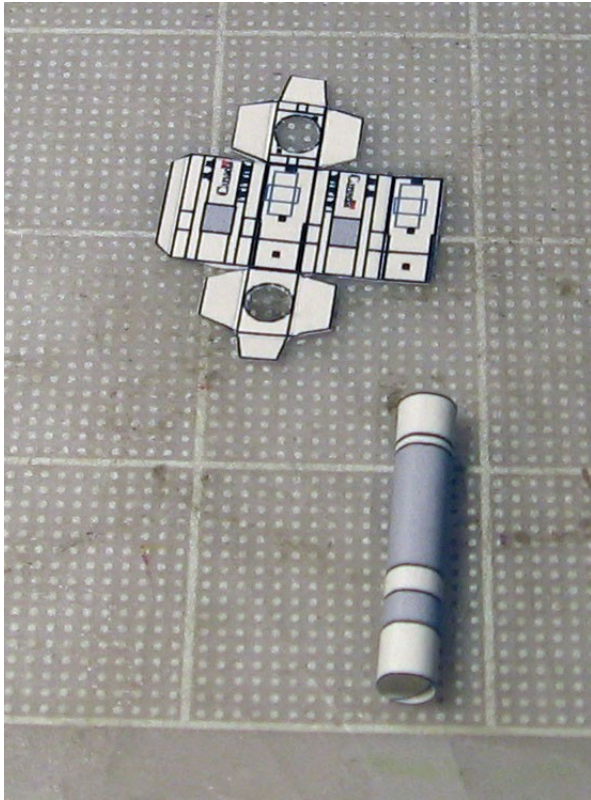

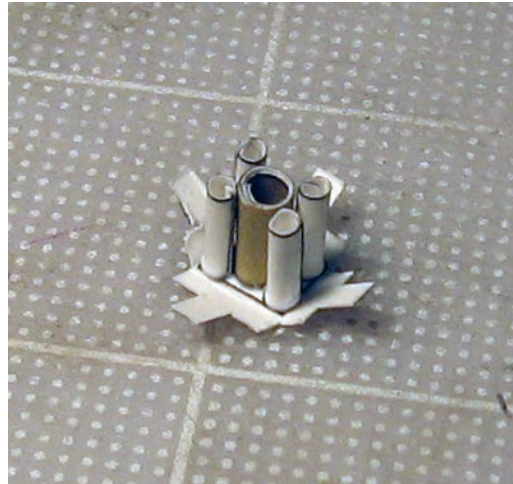
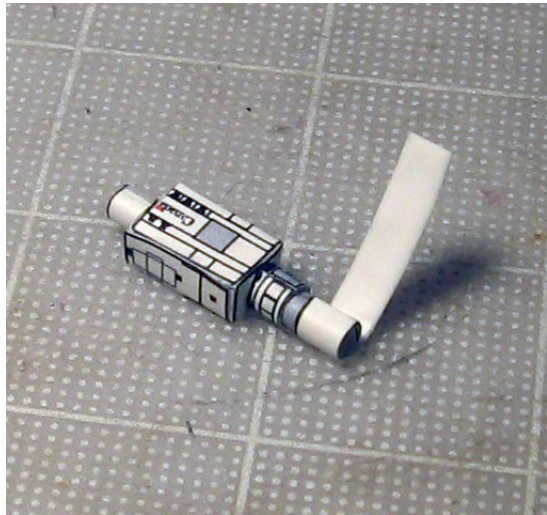
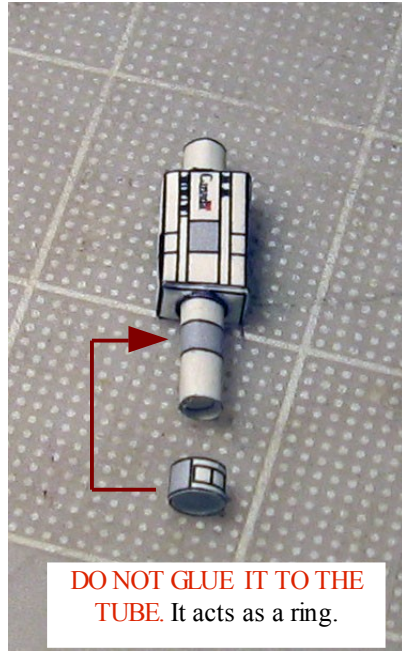

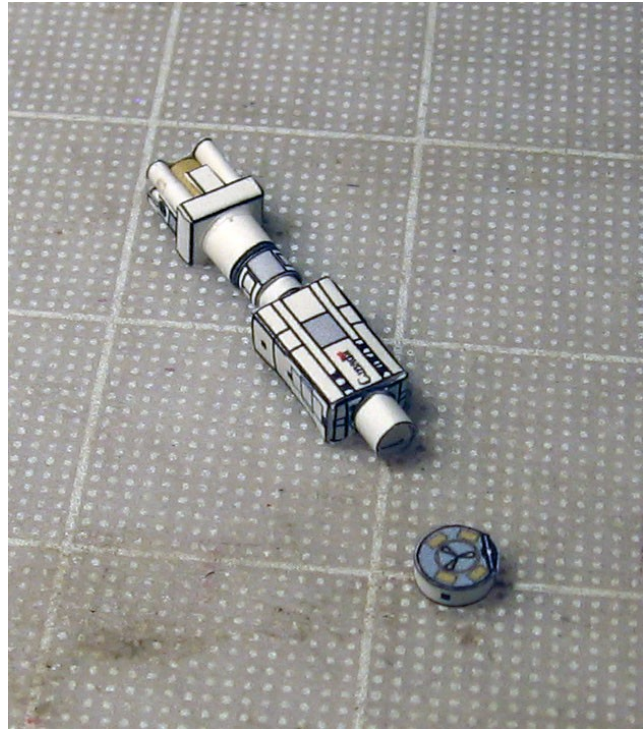
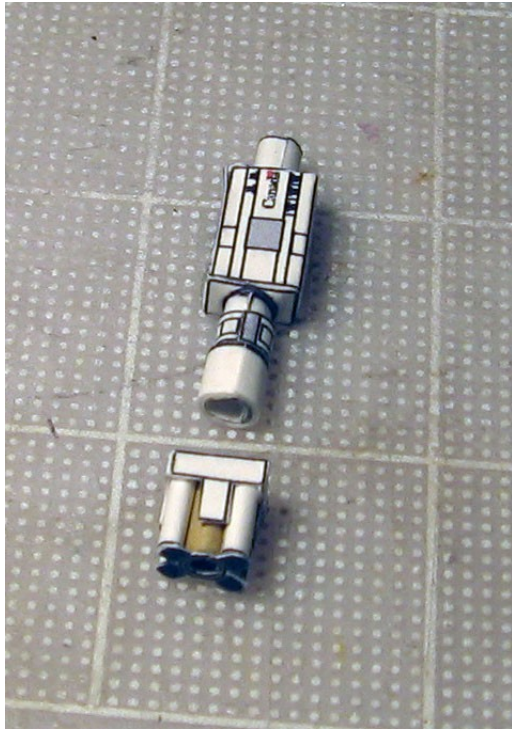

Building the arms supports and “legs”



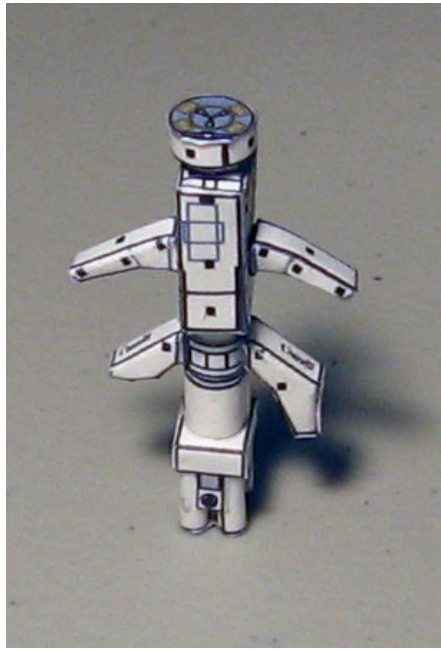
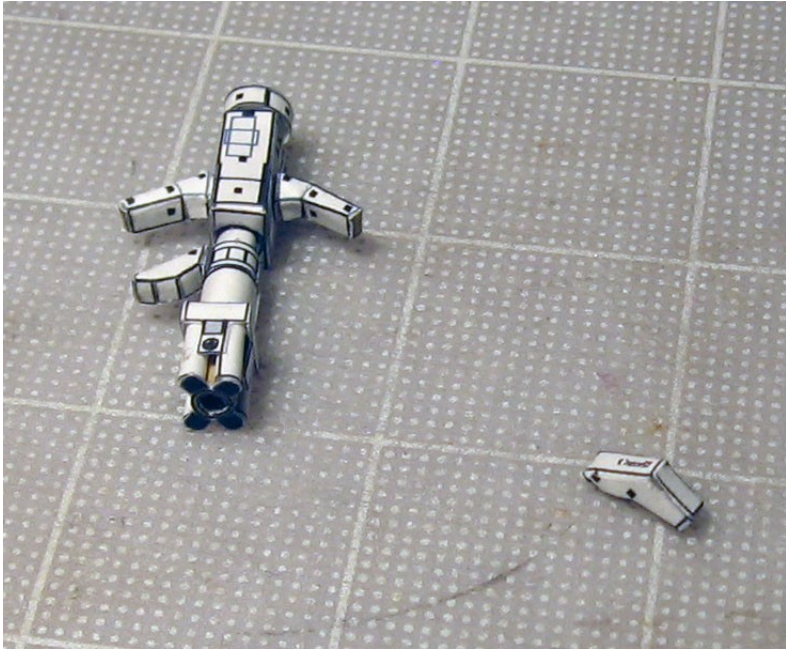

Adding the OTP (ORU Temporary Platform)

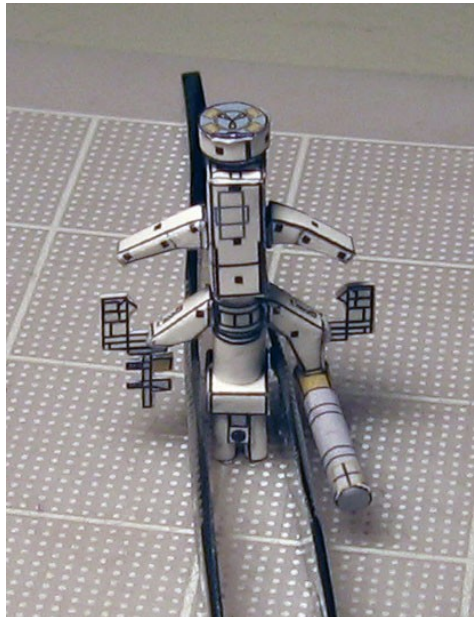
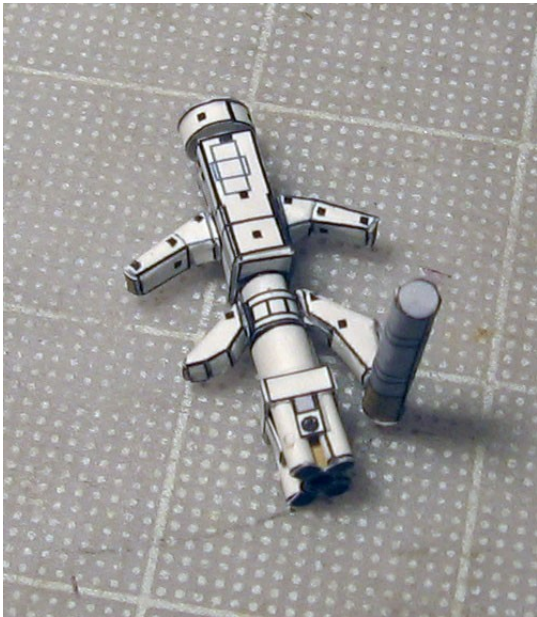

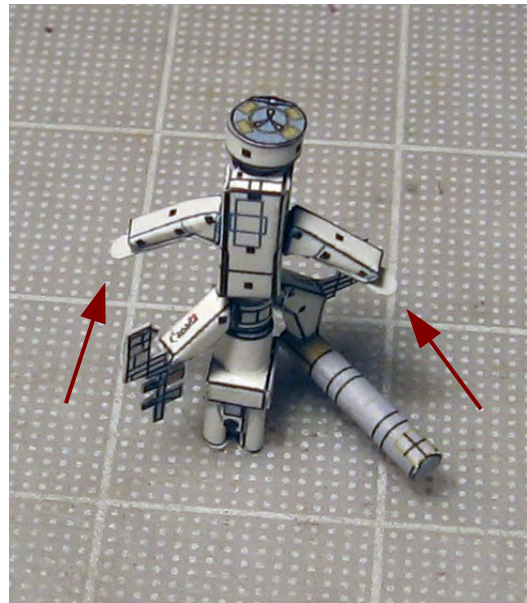
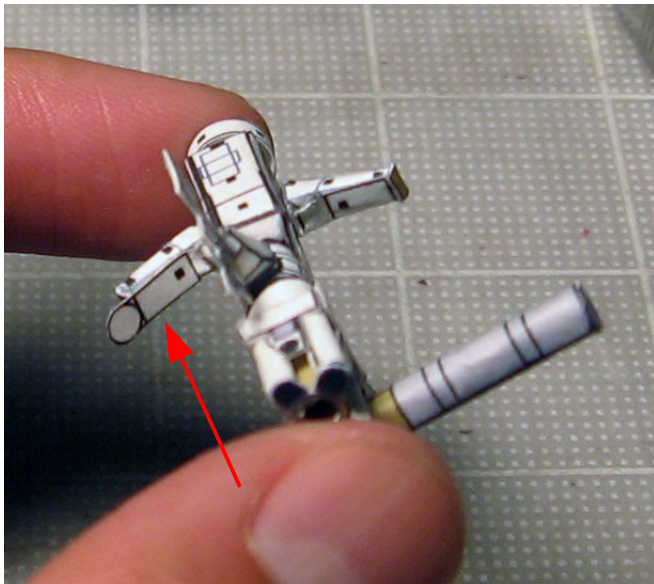

Building DEXTRE arms

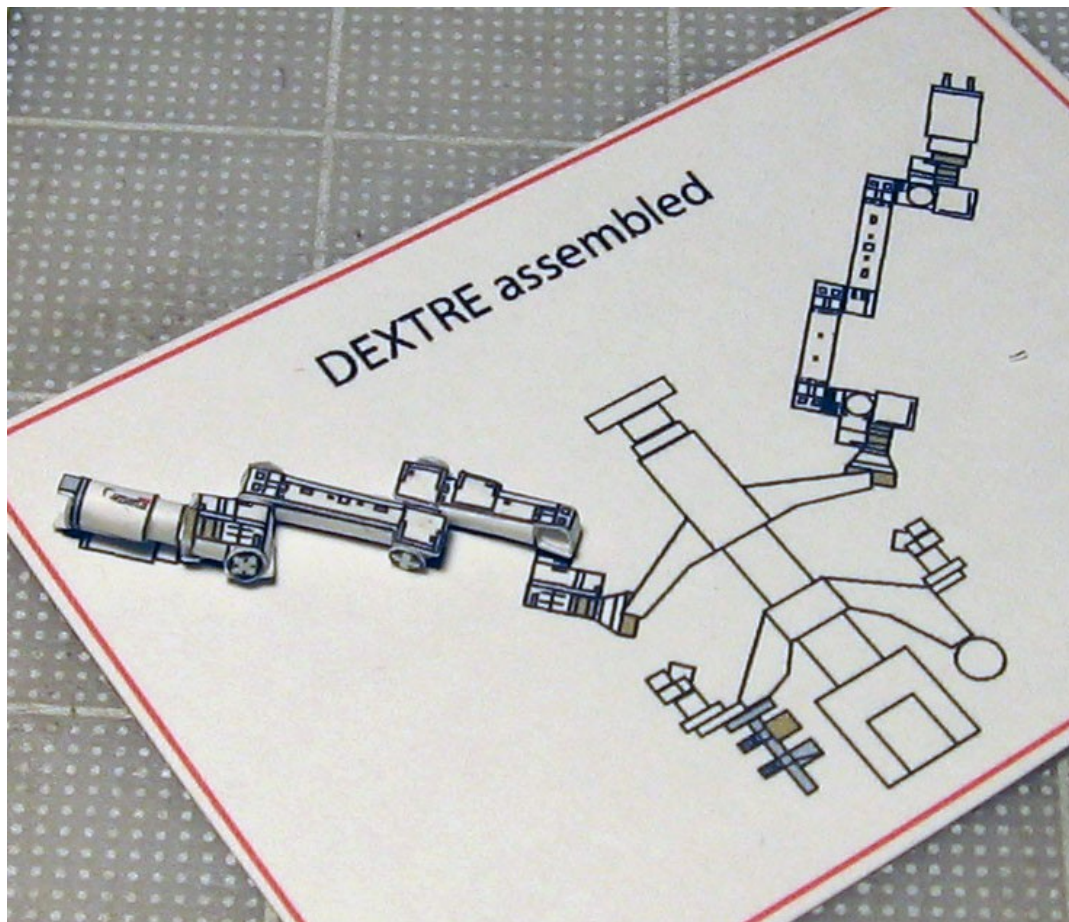

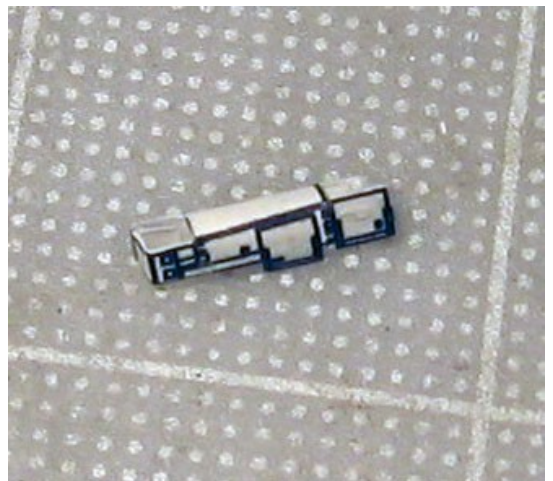
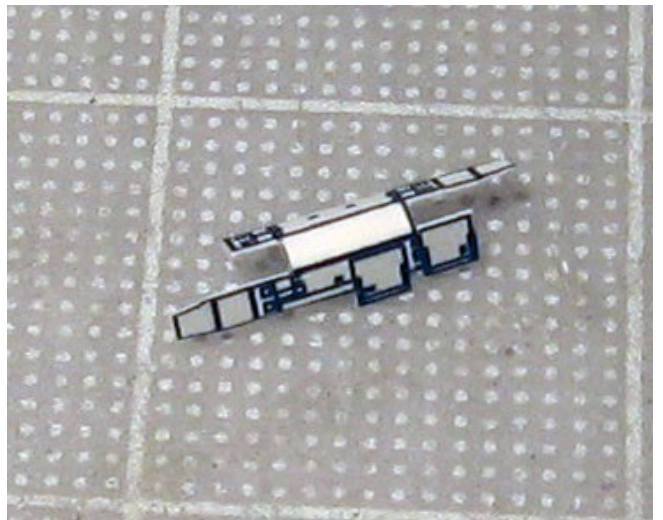
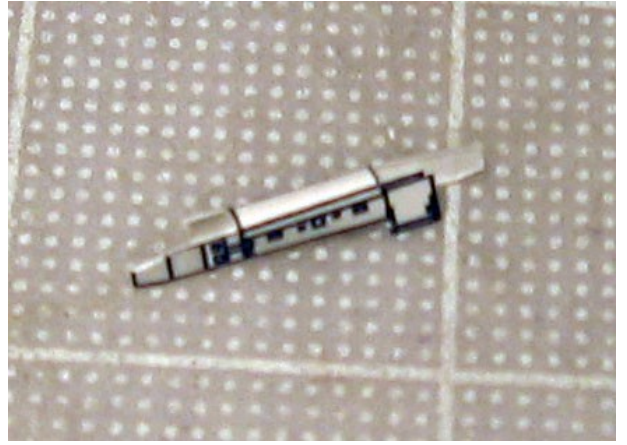
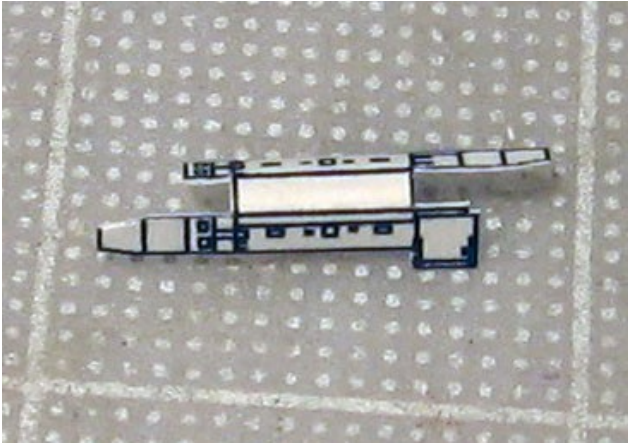

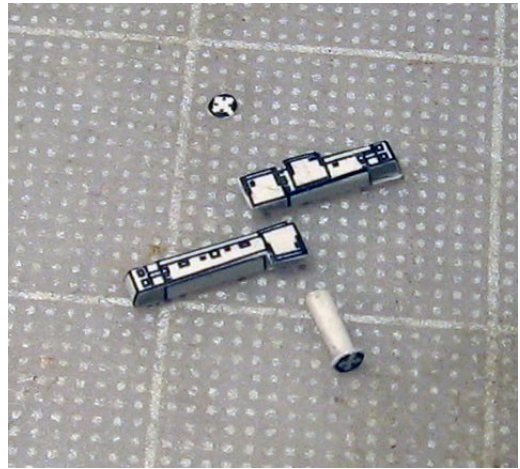

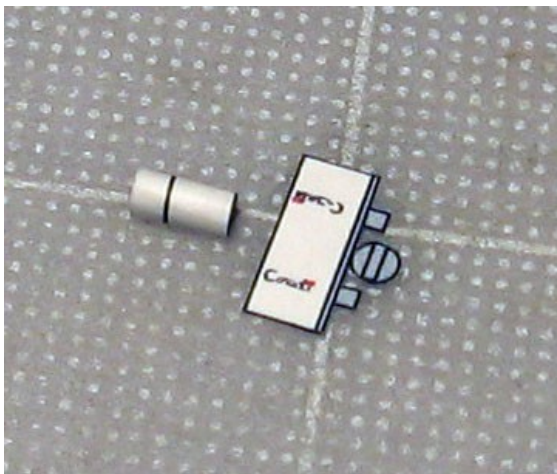

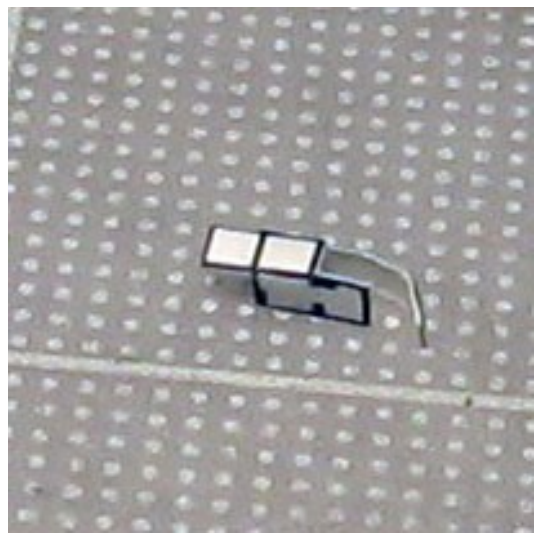
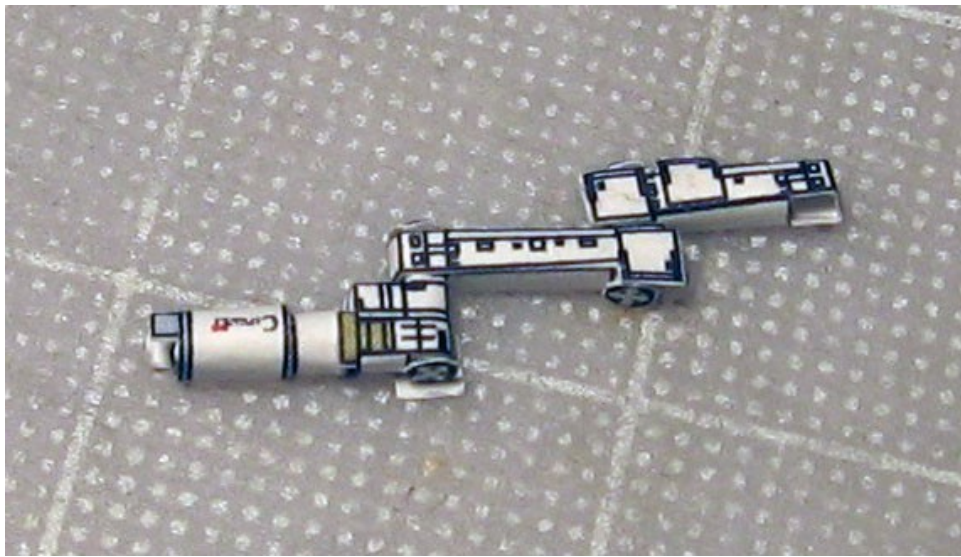
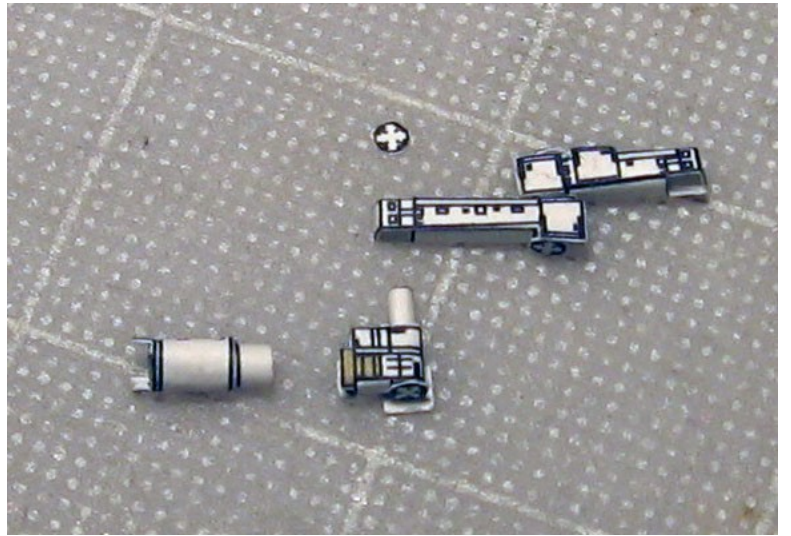

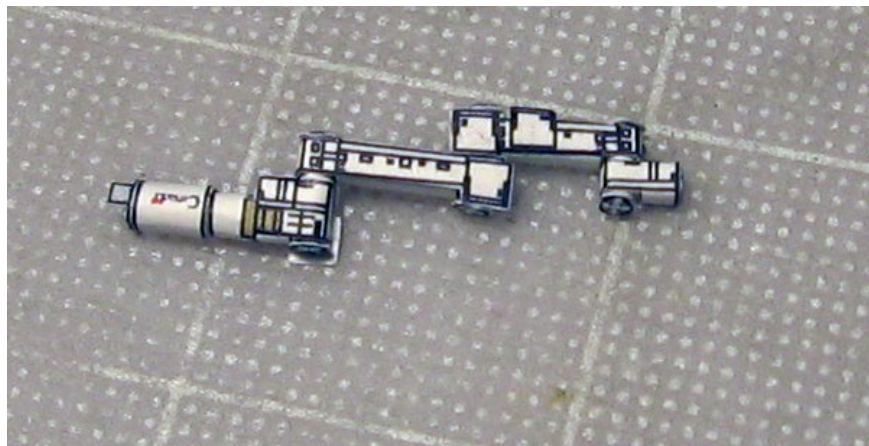
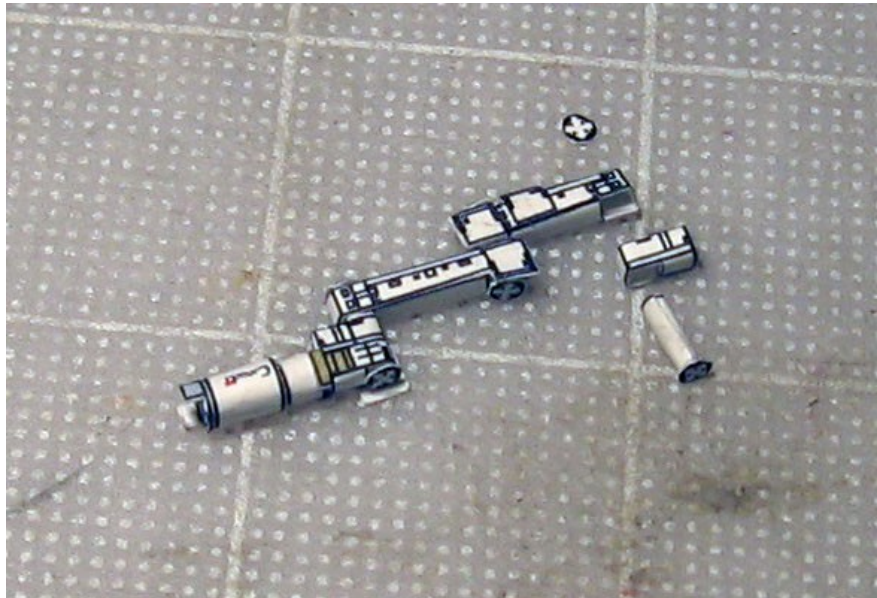
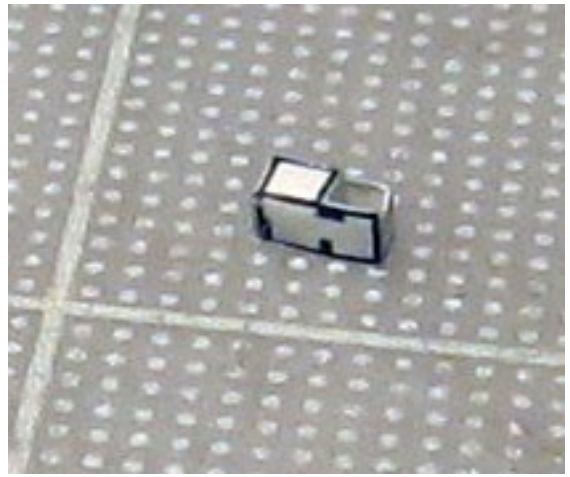
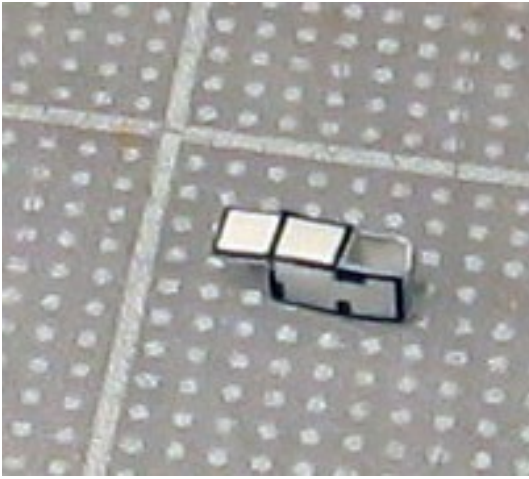

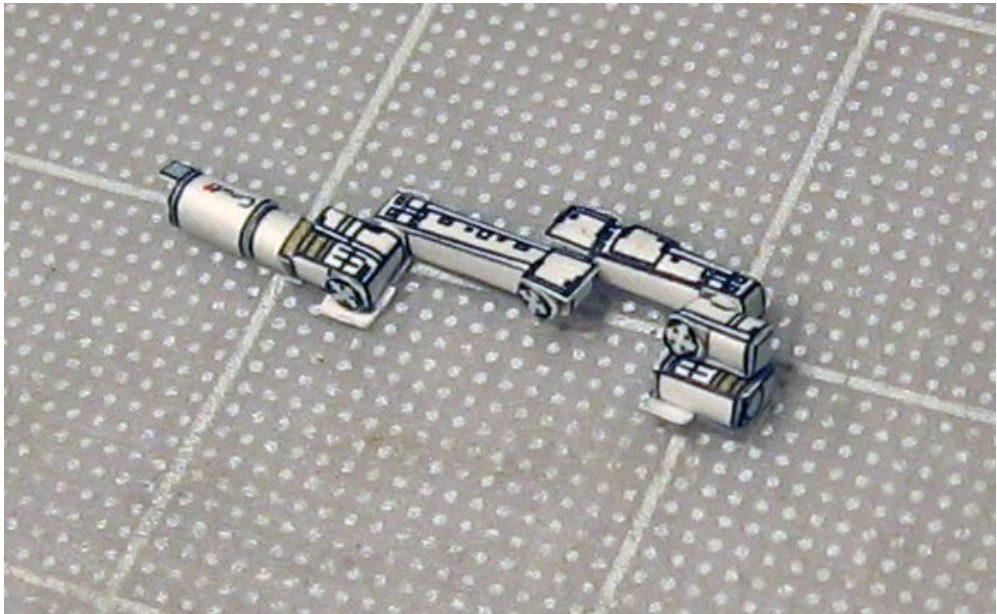
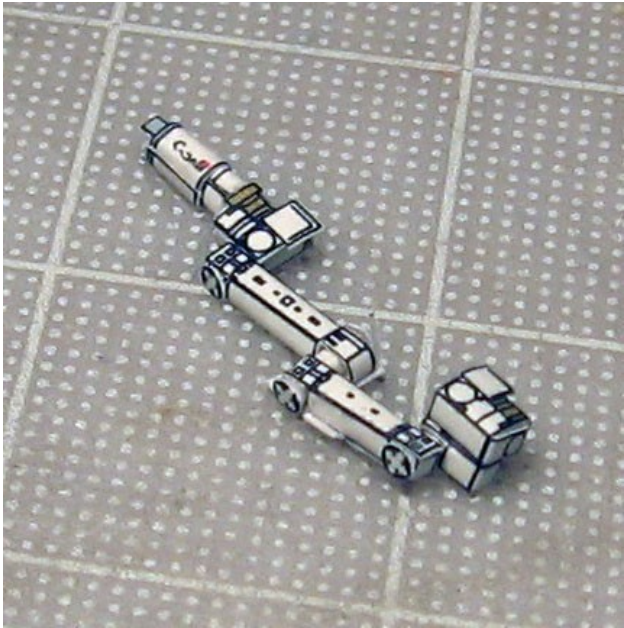
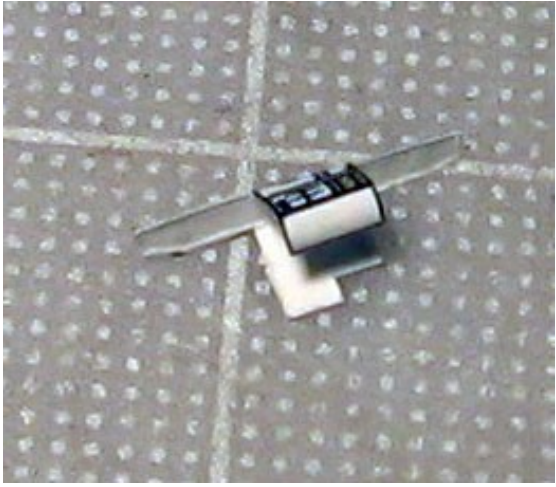

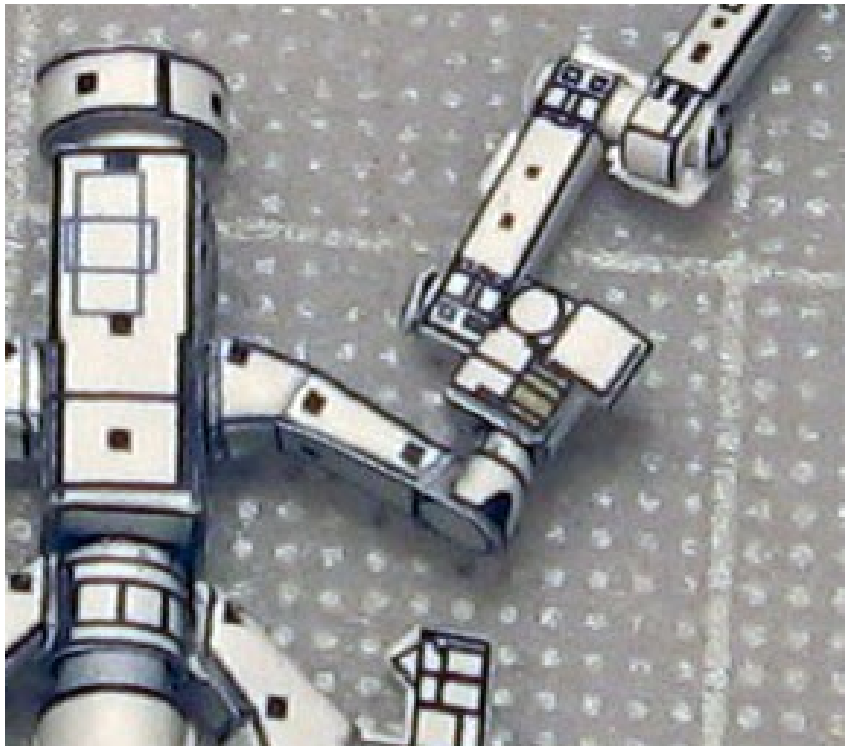
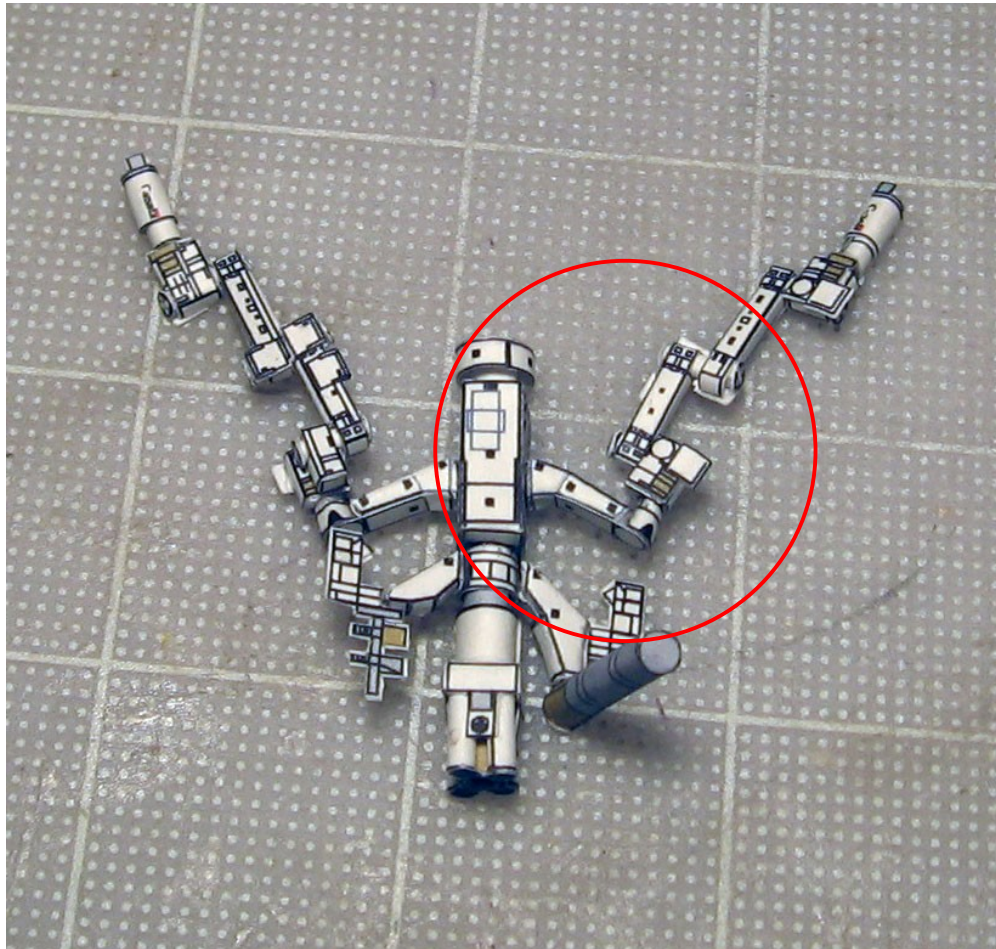

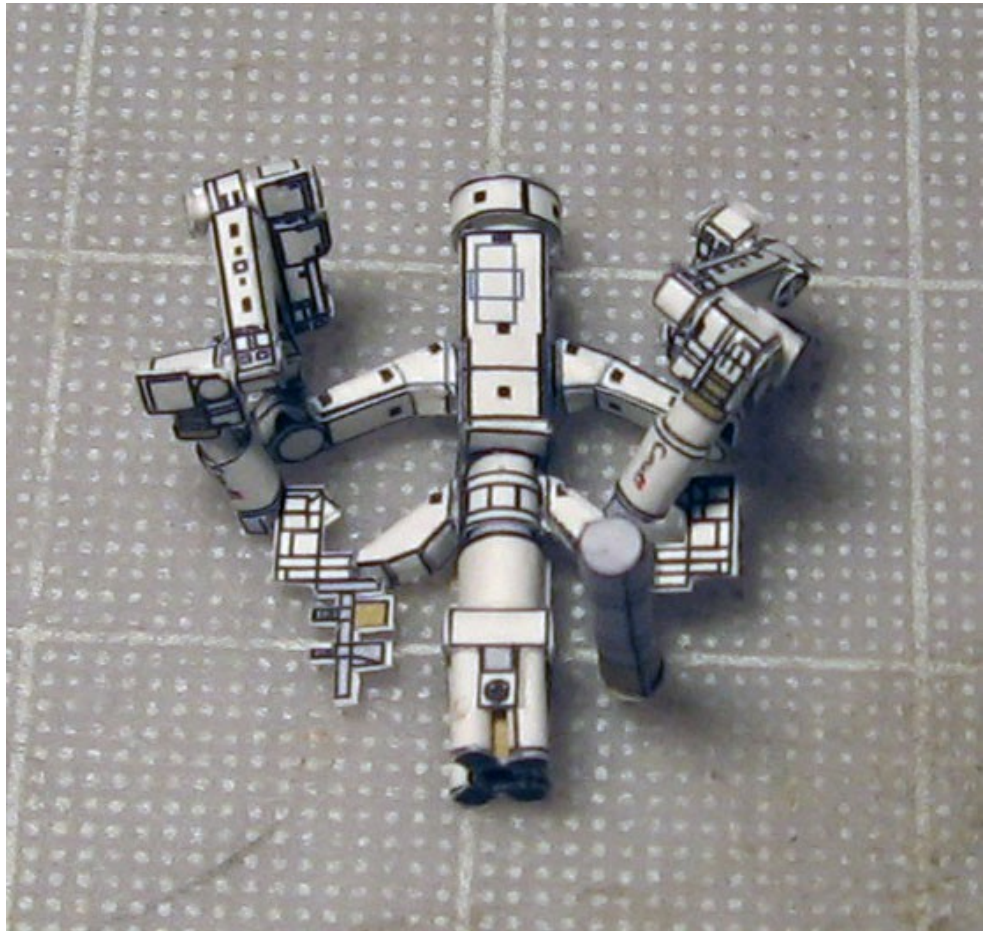
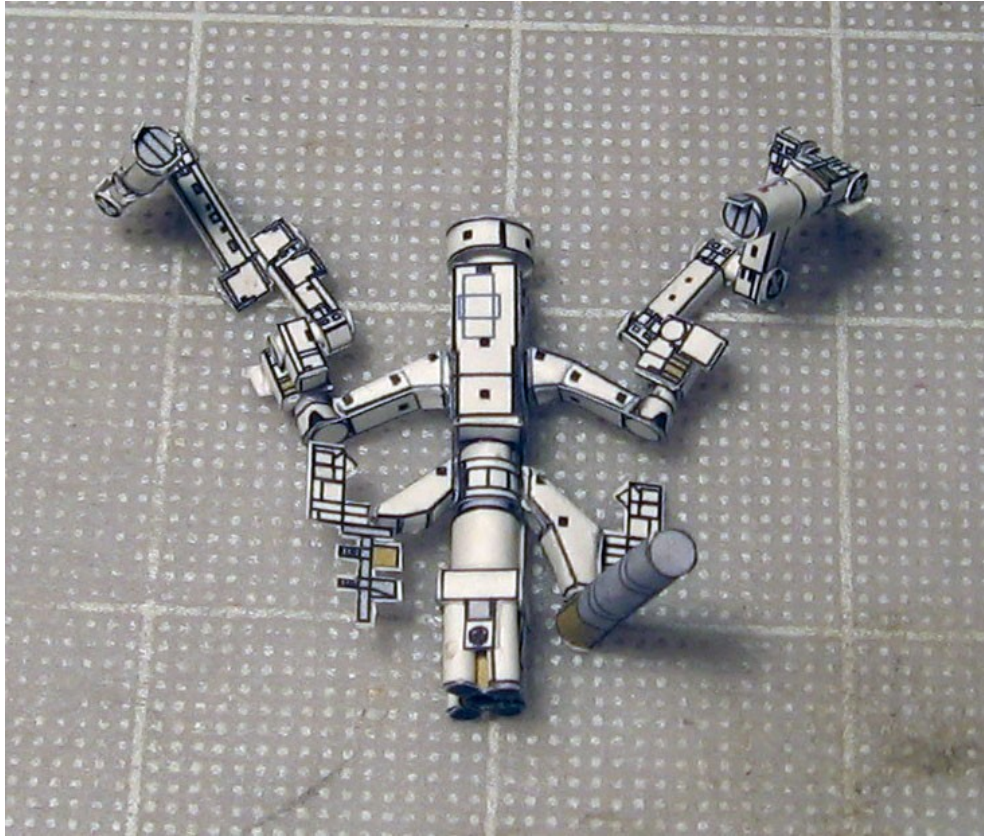

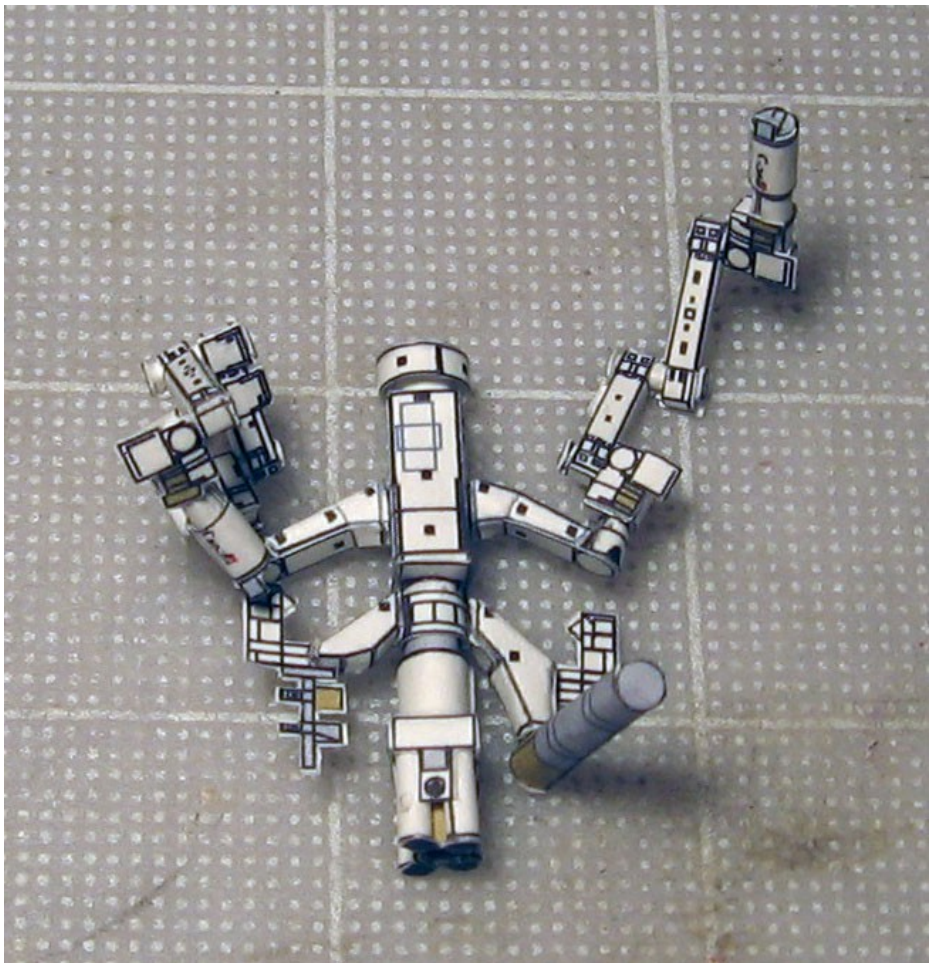
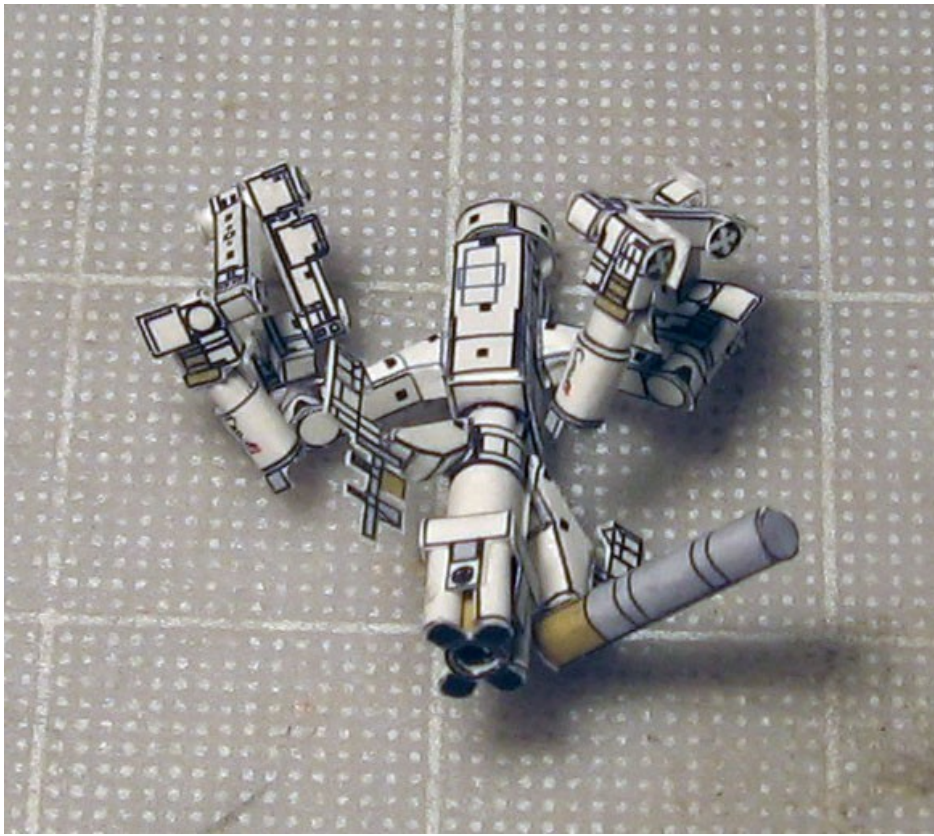

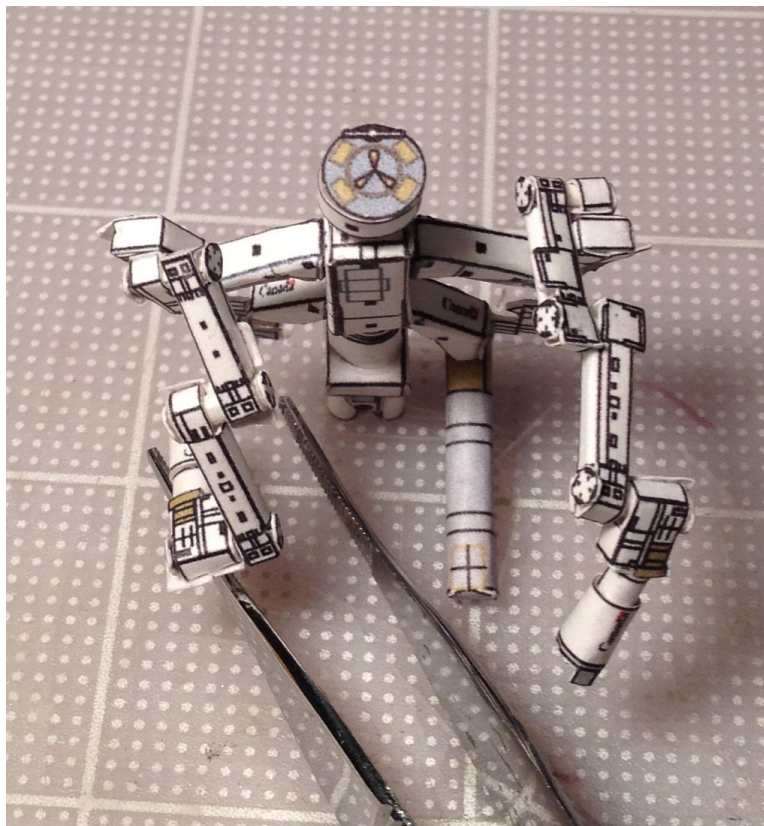
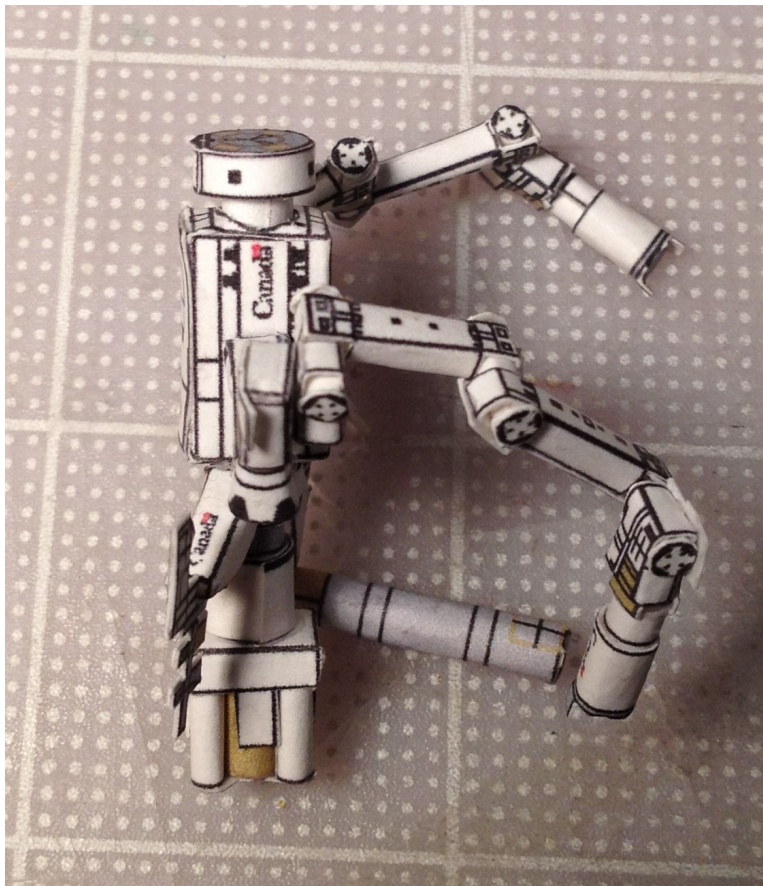

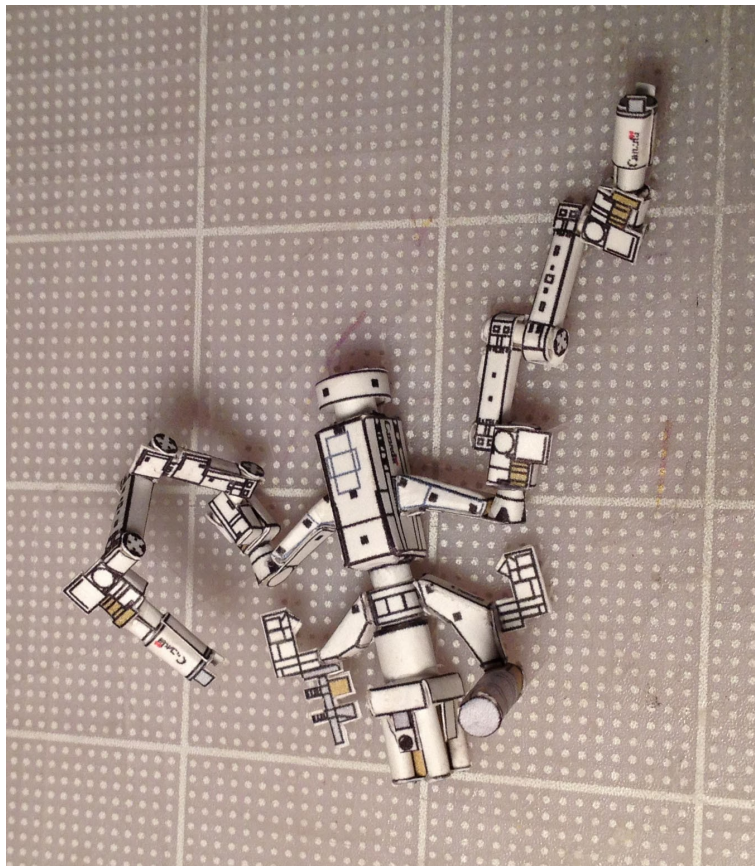
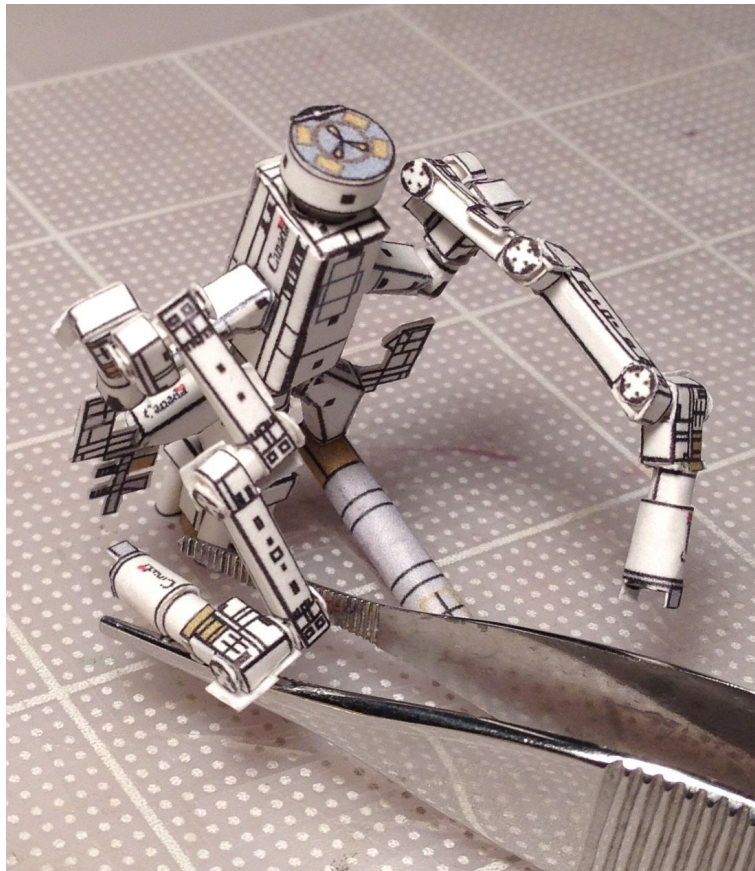

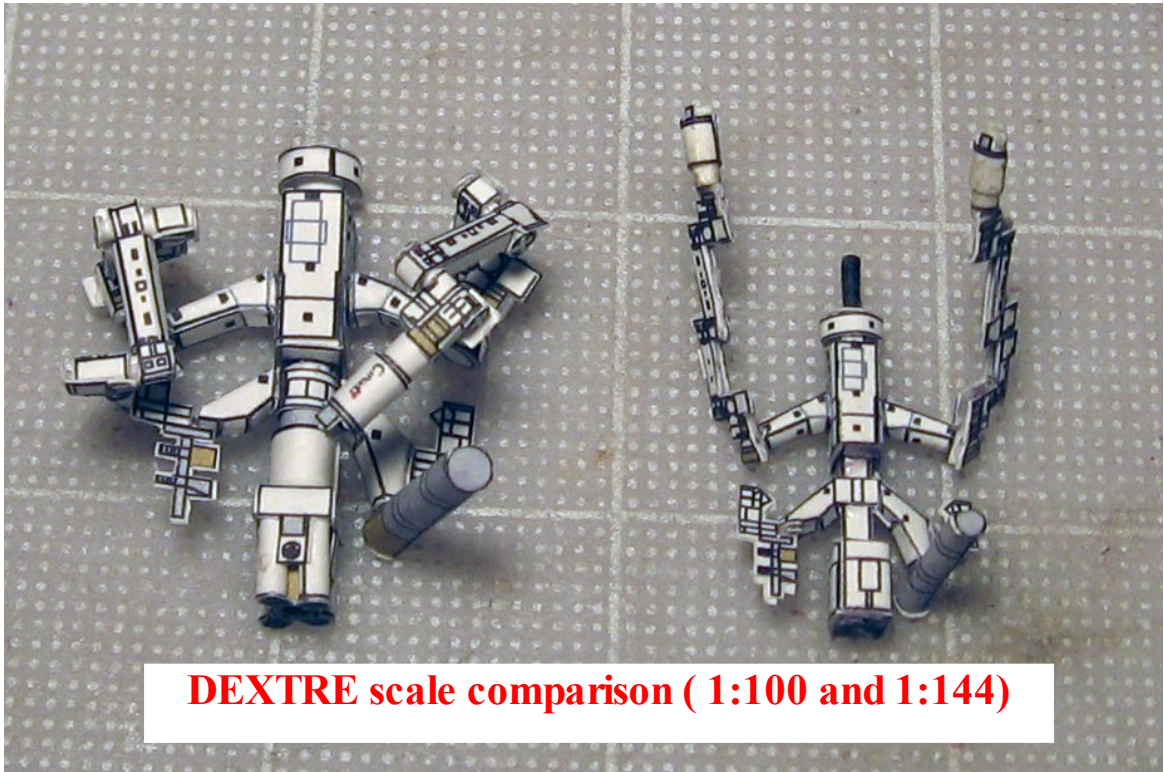

DEXTRE scale comparison (1:100 and 1:144)

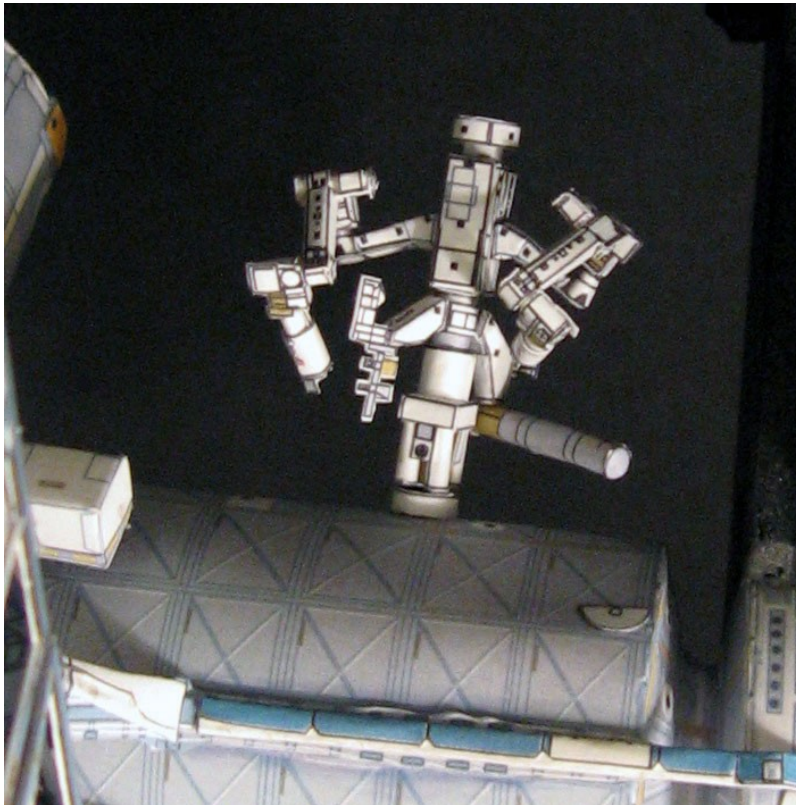

<http://www.axmpaperspacescalemodels.com>