

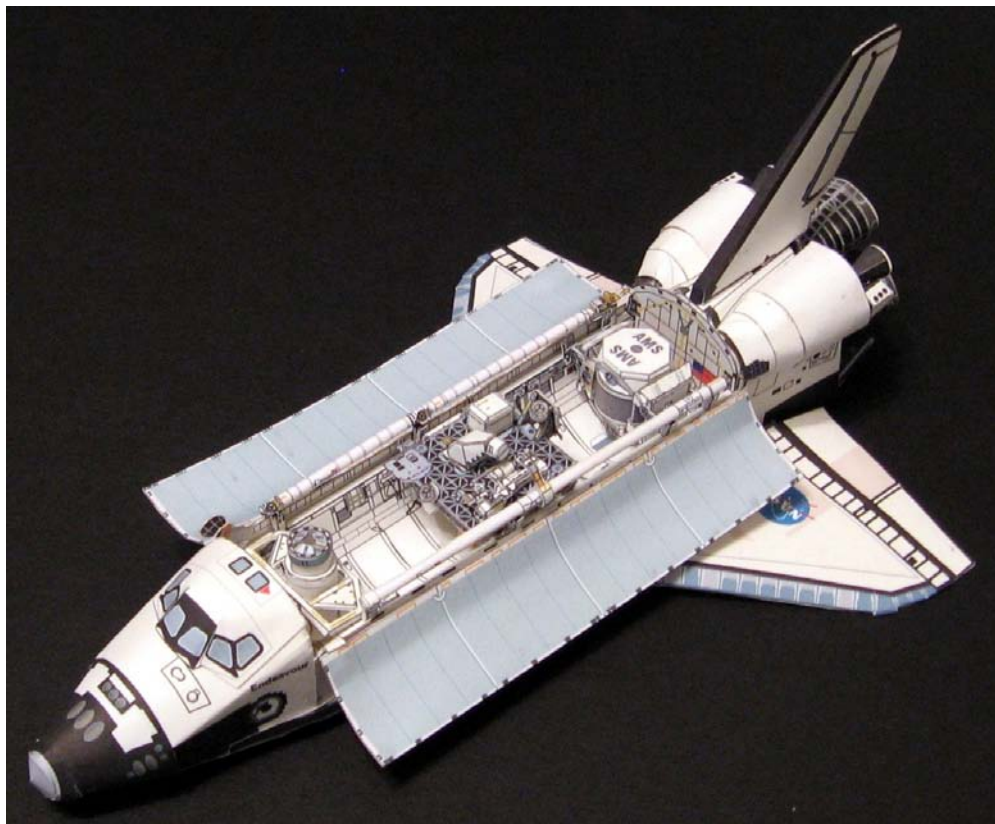

© 2011

# Assembly Instructions for STS-134 payload





**Building the AMS-02 (Alpha Magnetic Spectrometer-2)**  
(Assembly is the same for both scales 1:144 and 1:100)

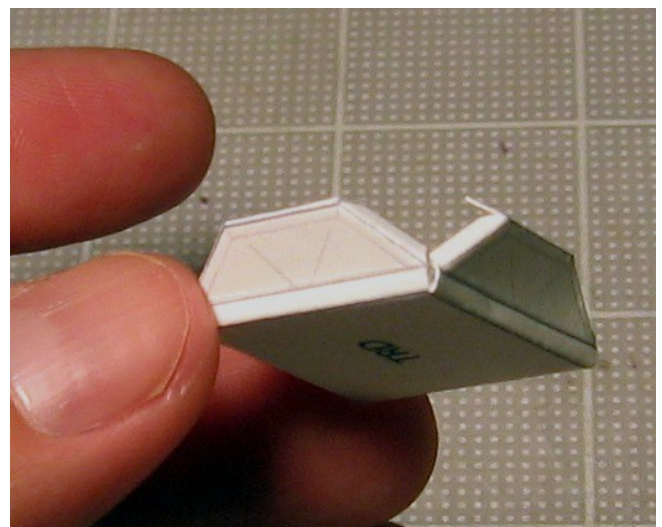
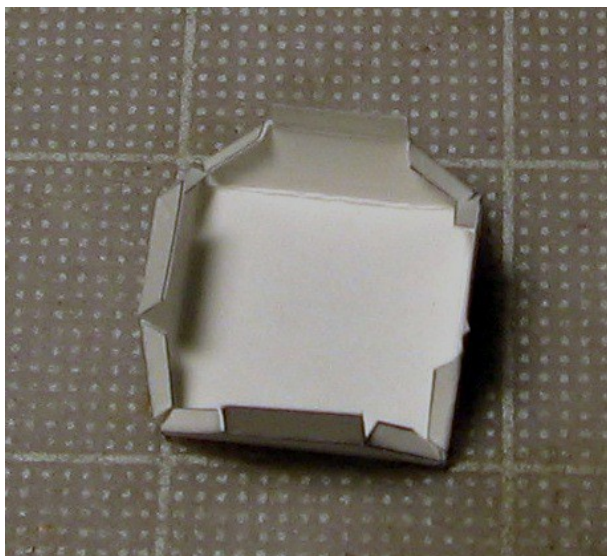
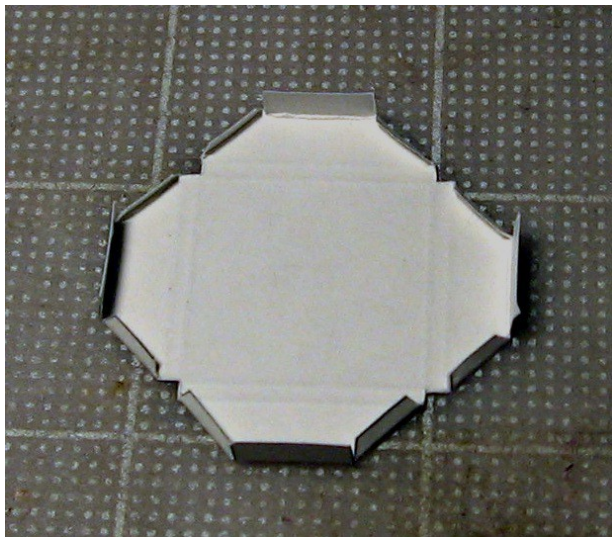
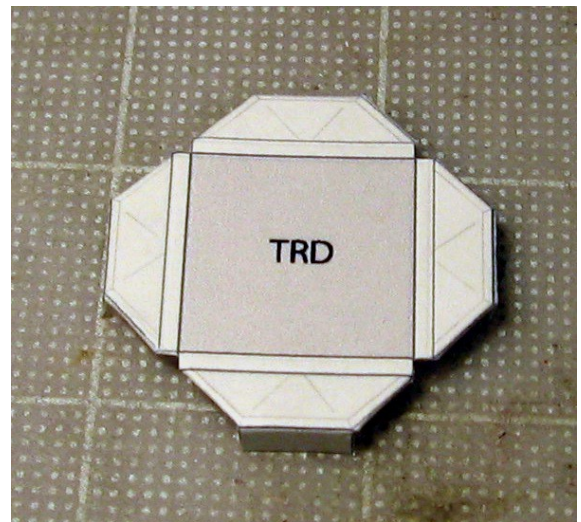
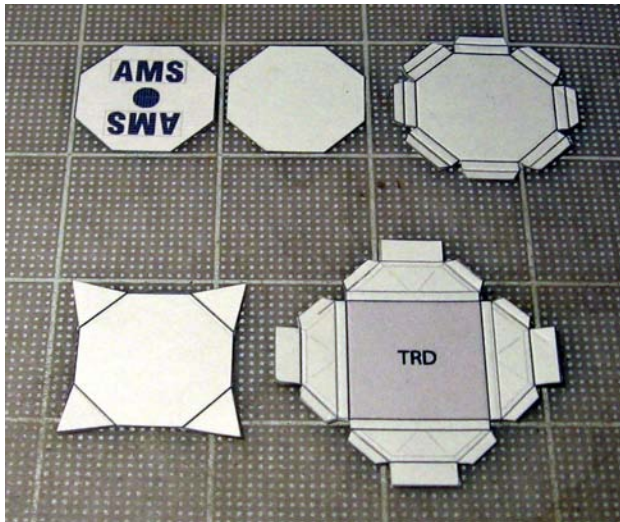



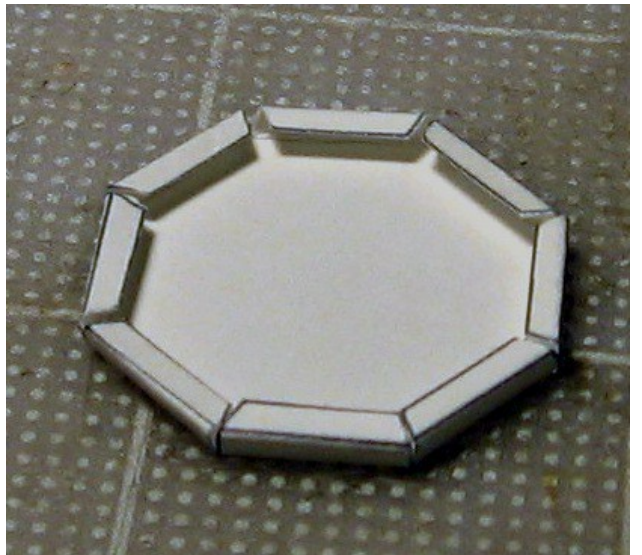
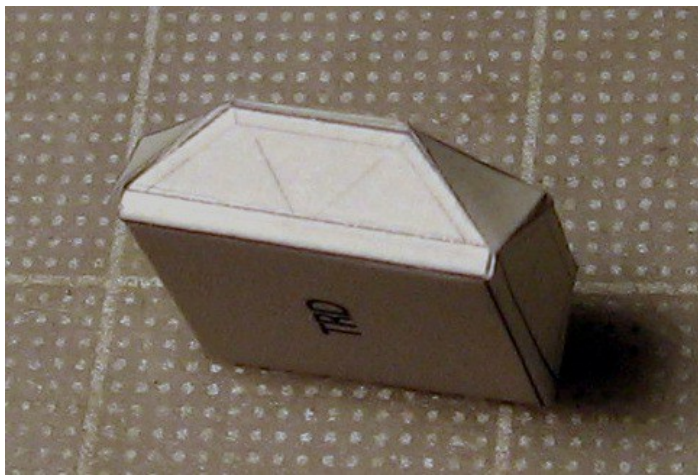
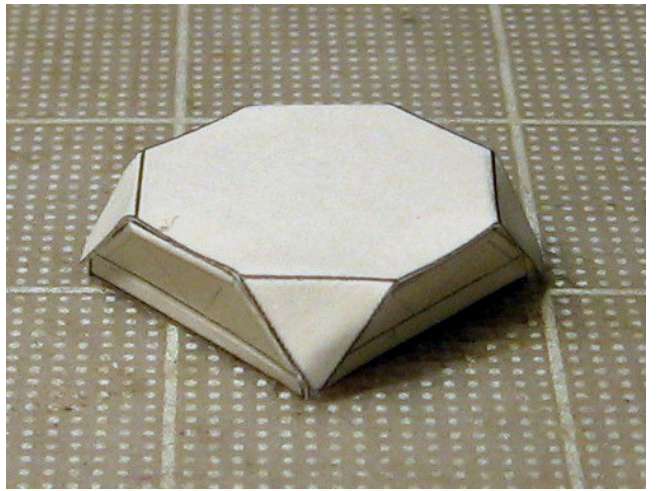
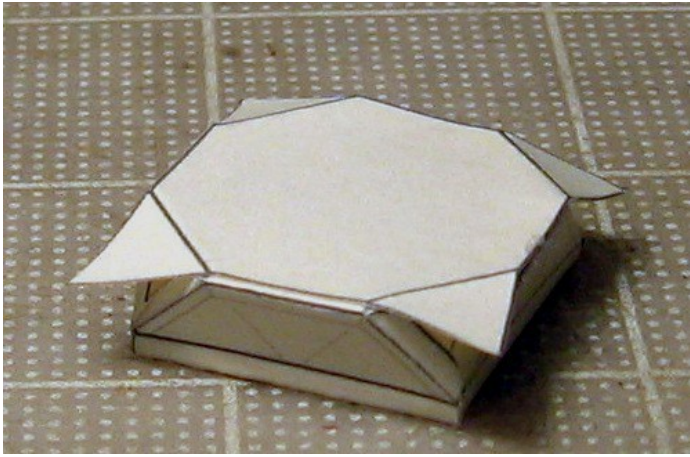
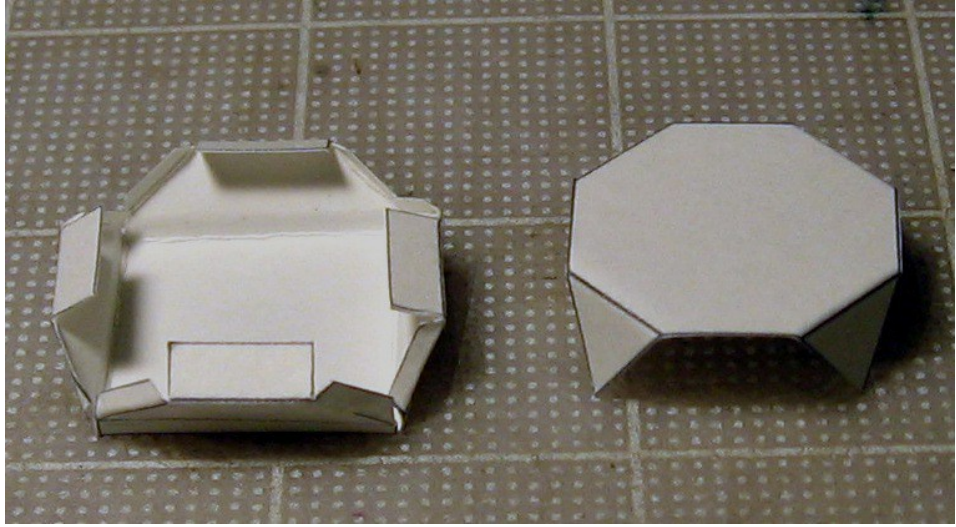



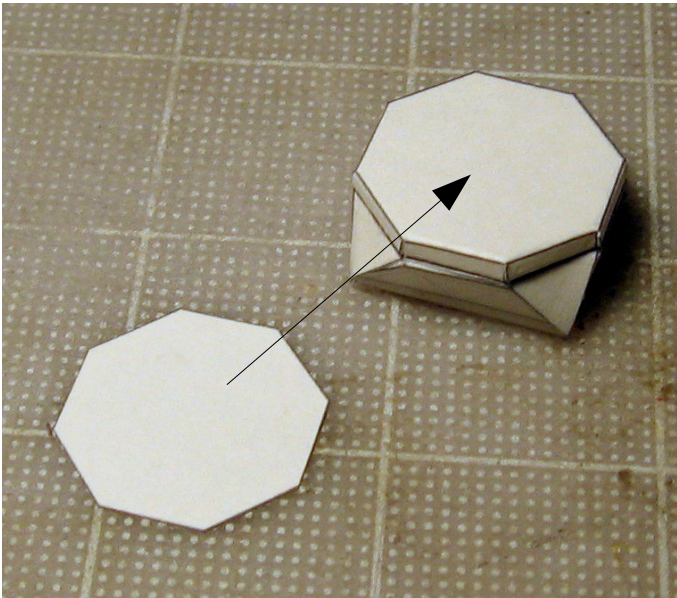
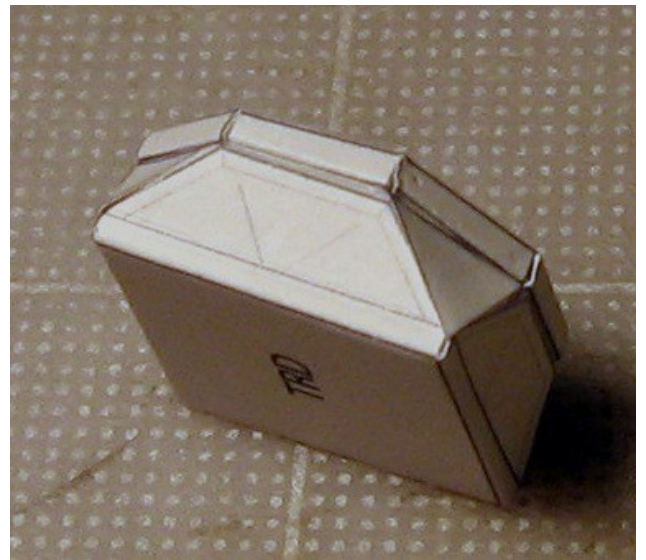
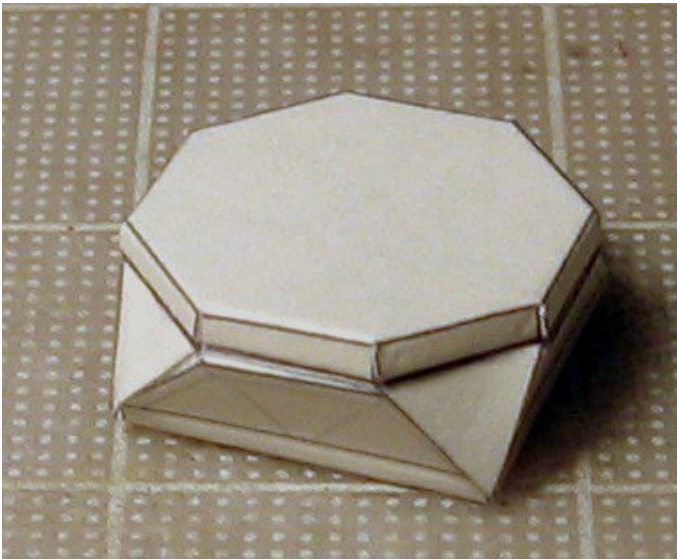

The blank octagon is glued on top of the whole structure. On the 1:144 scale version, there is no extra octagon part, but do not glue the octagon with the AMS logos until the end of the assembly.

The octagon with the AMS logo is not glued at this stage because if it's glued then it can get dirty when handling the model while gluing other parts.

**Do not glue the octagon with AMS logos until the end of the assembly.**

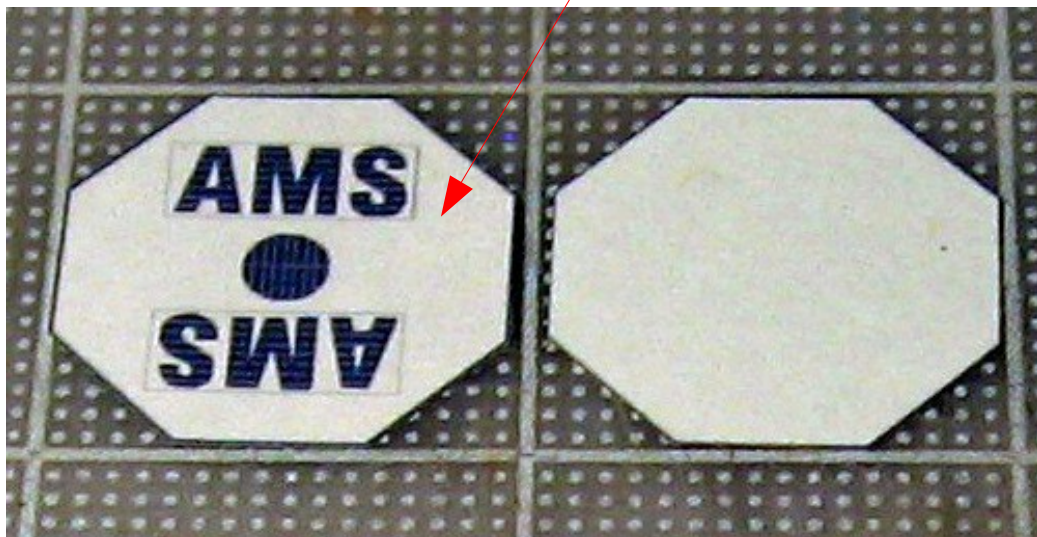



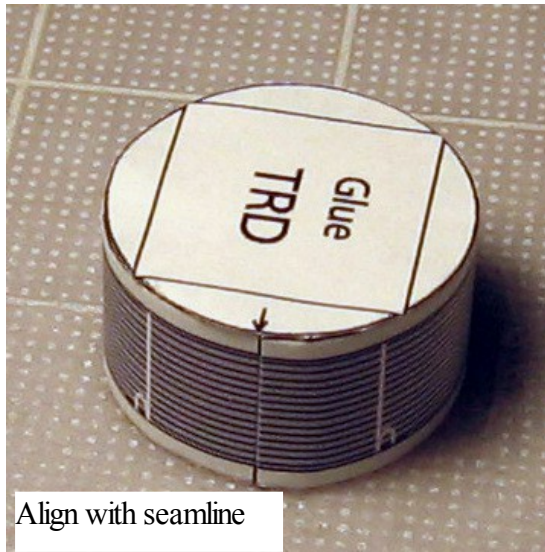
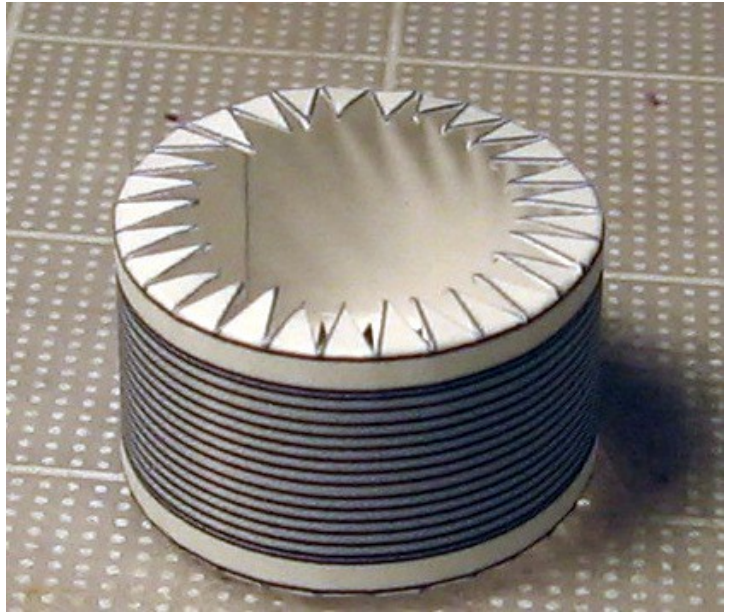
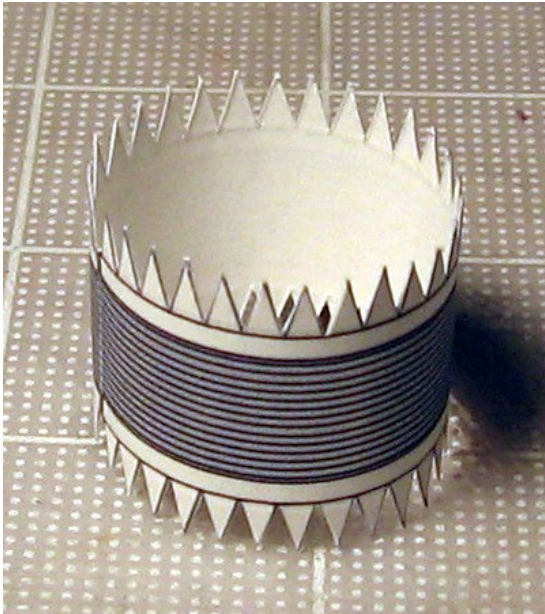

Align with seamline

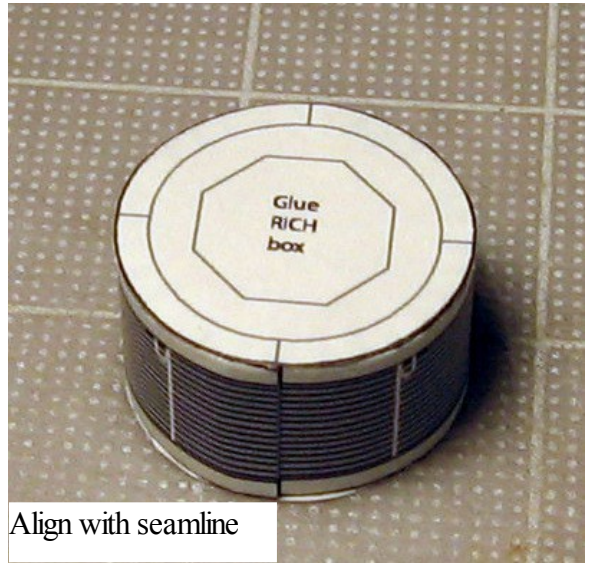

Align with seamline

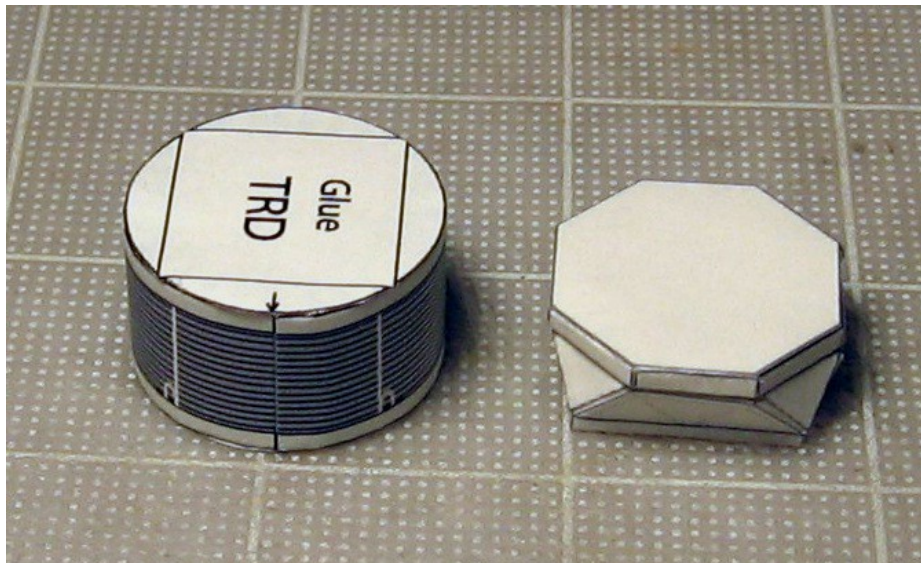



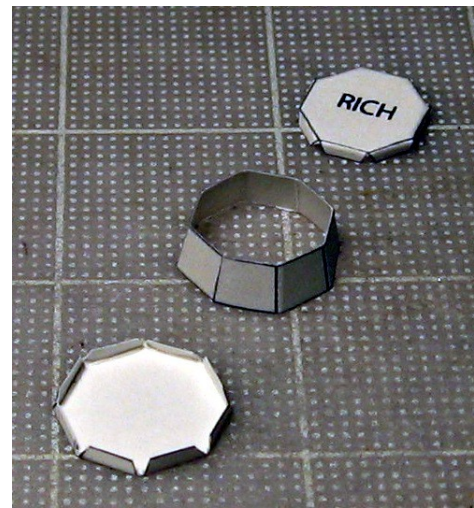
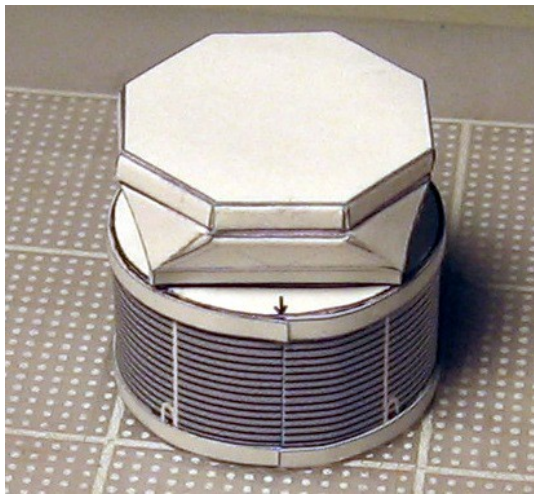
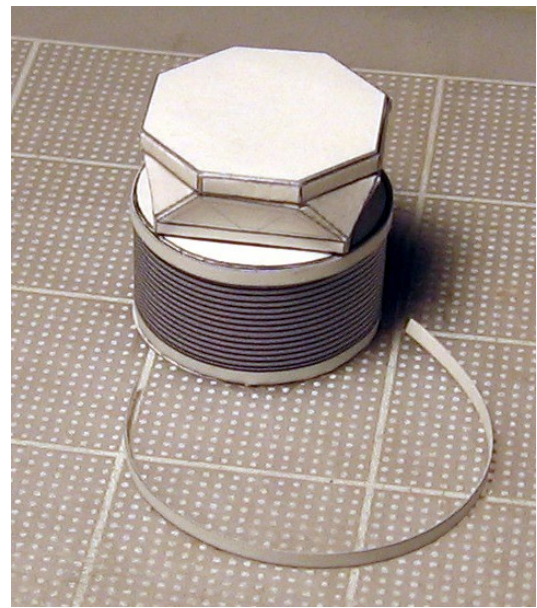
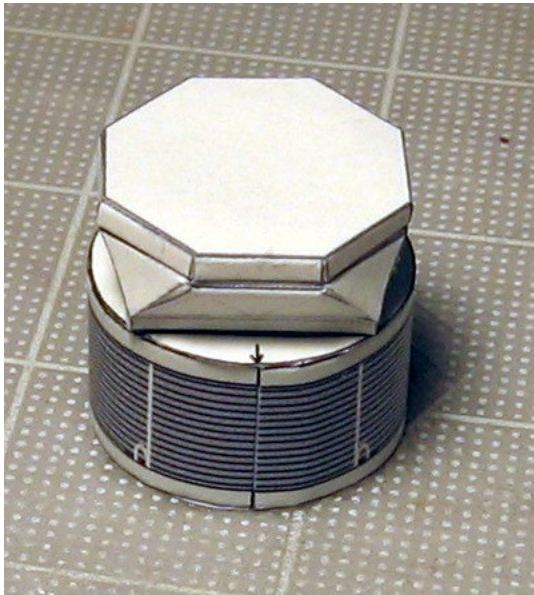



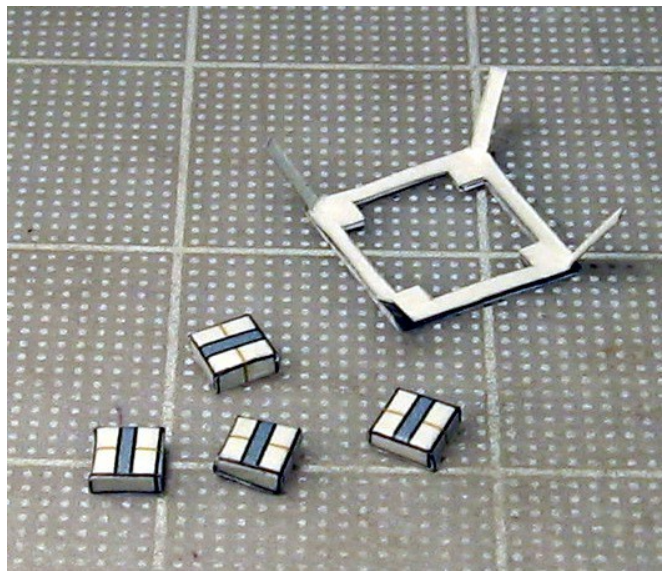
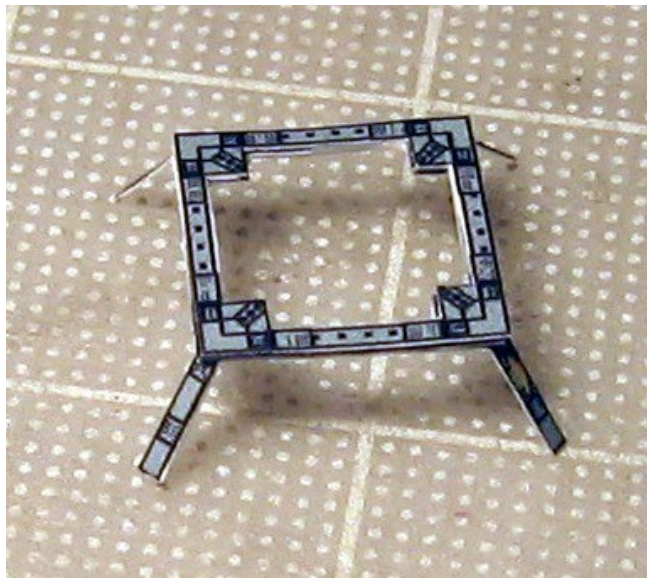
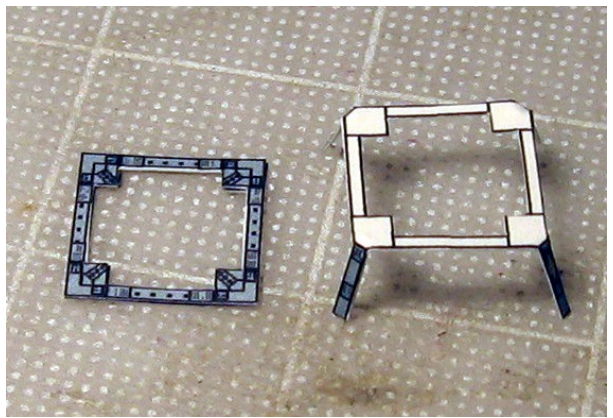
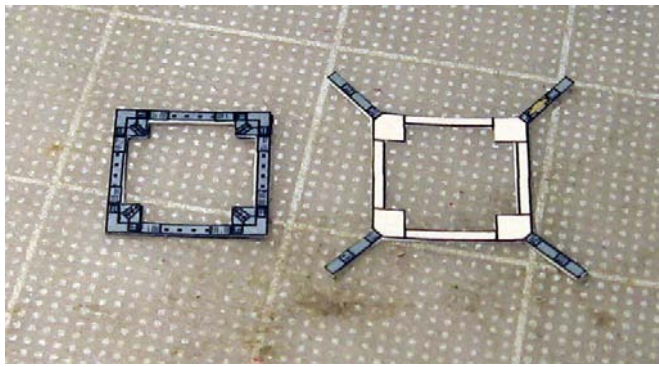
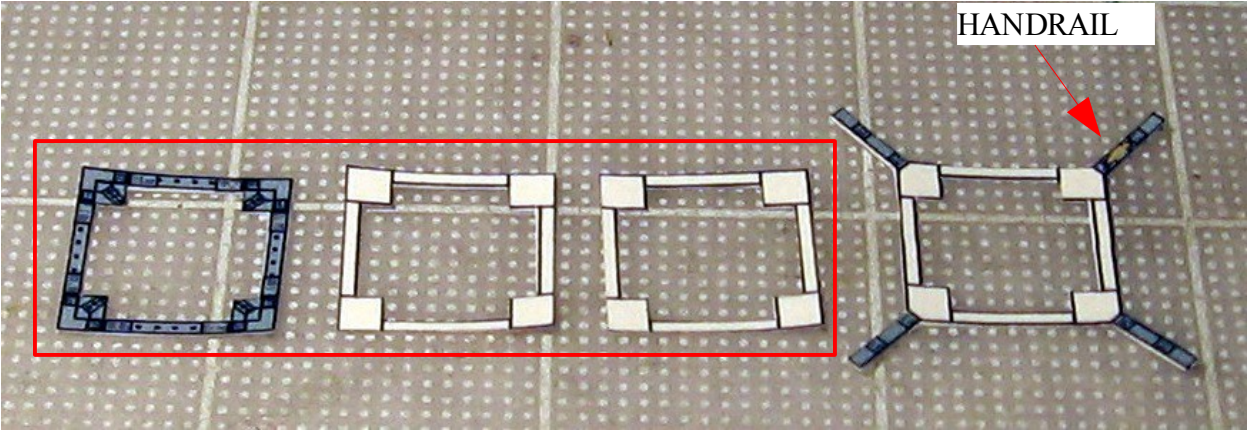



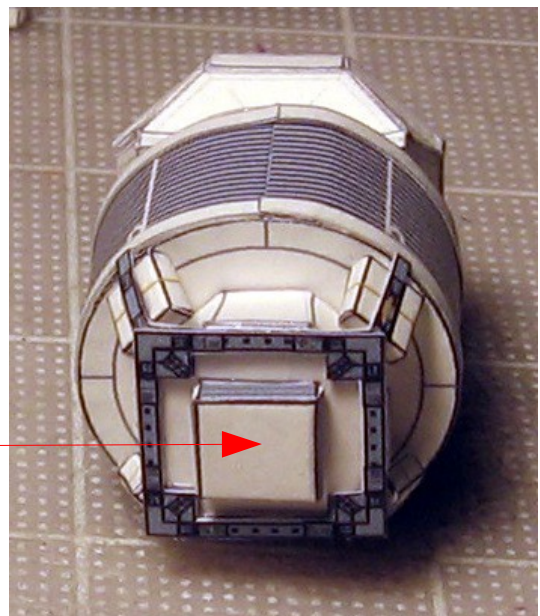
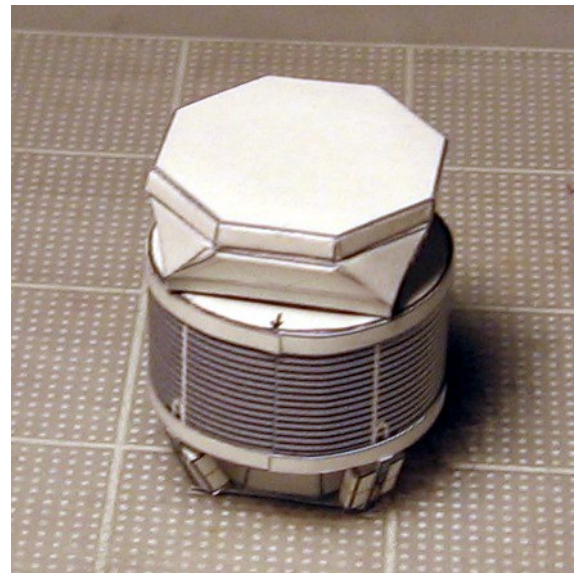
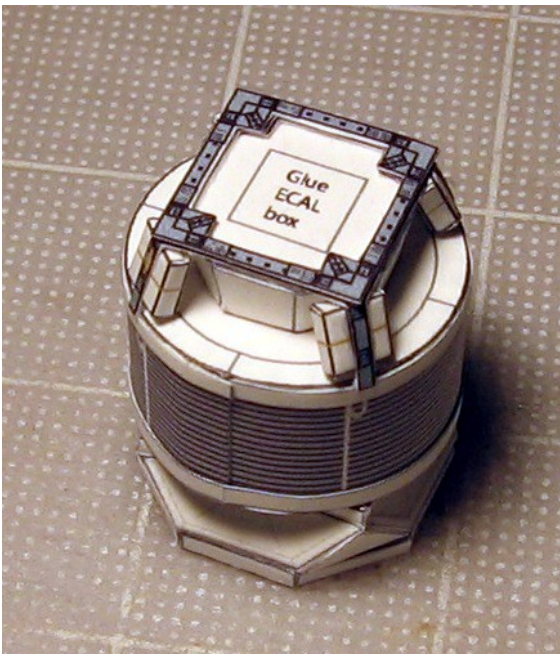
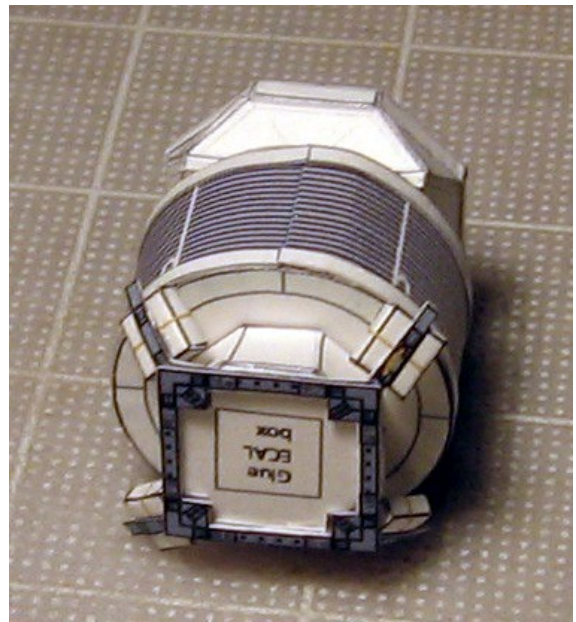
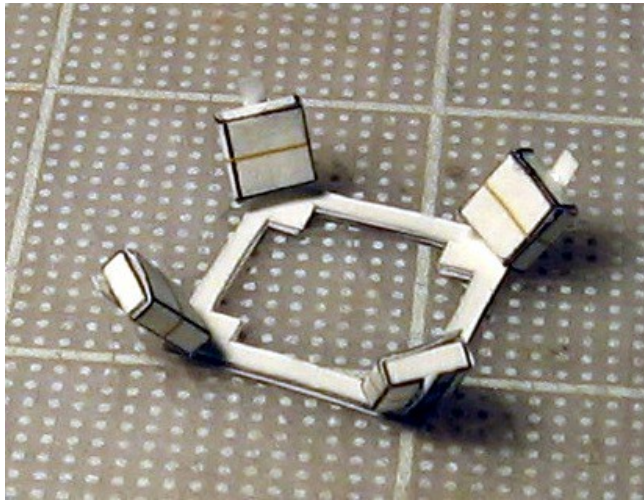

ECAL BOX



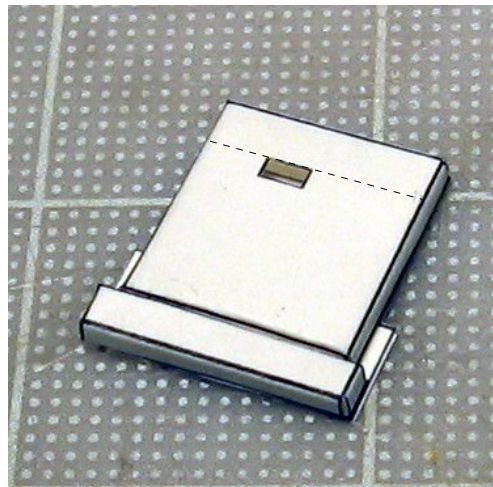
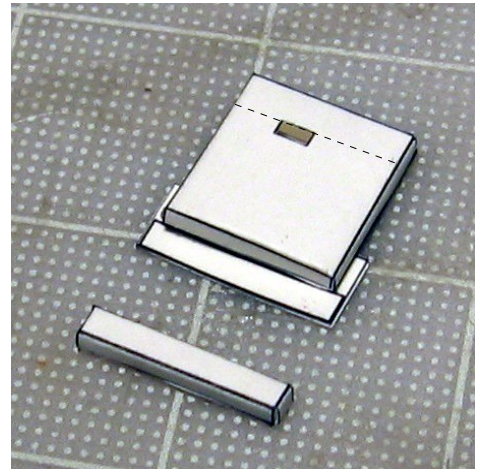
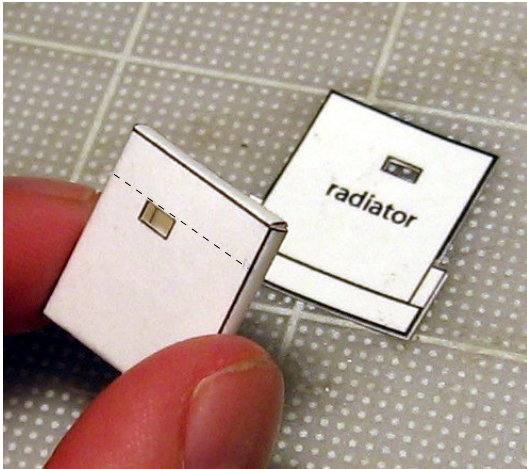
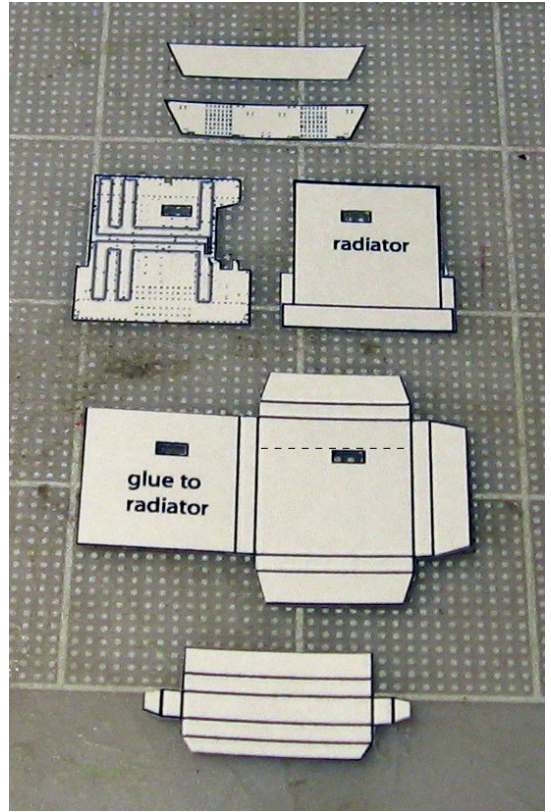
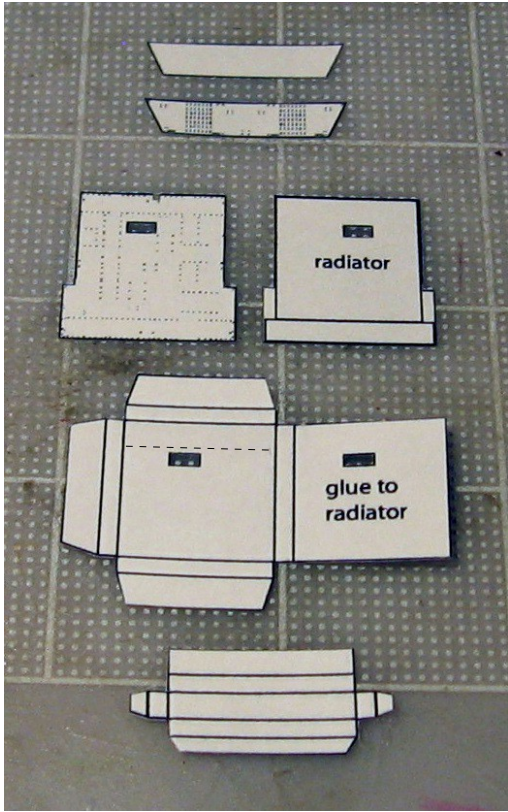



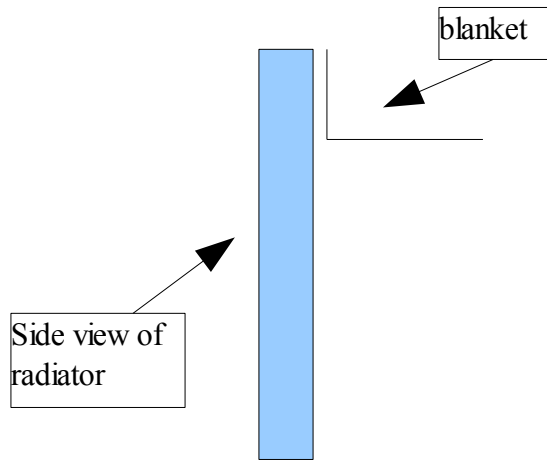
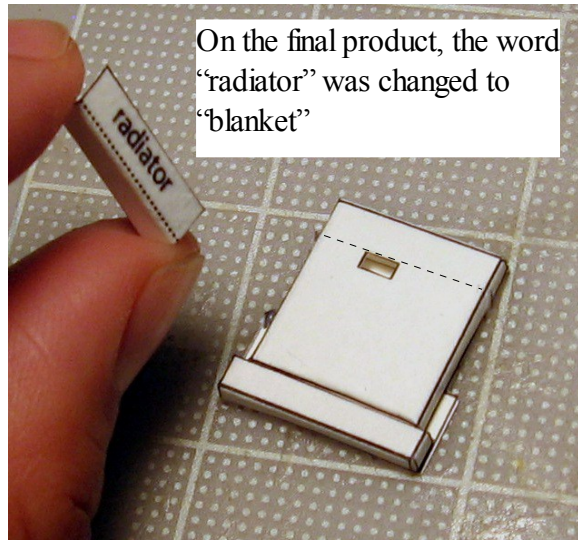
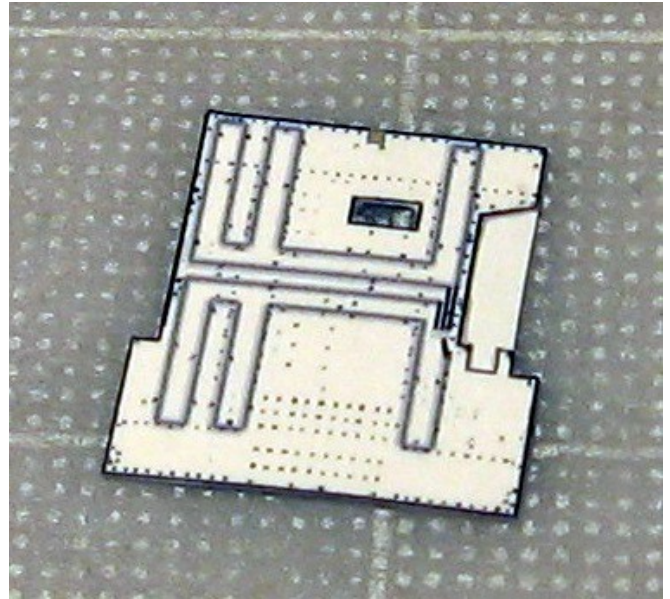
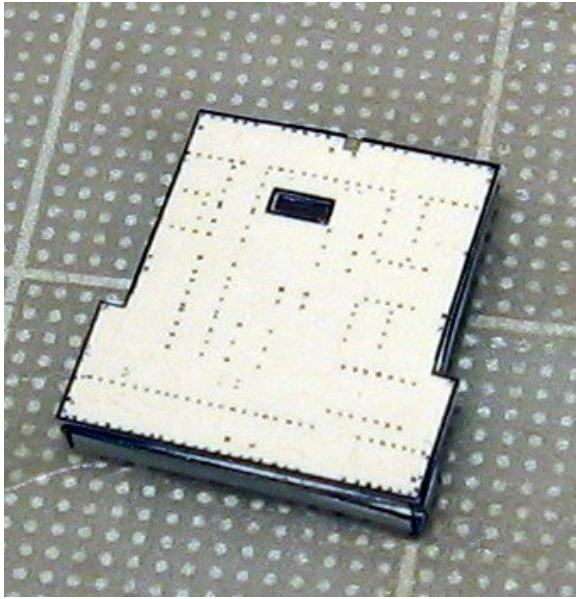

**IMPORTANT**

Glue the radiator with dots onto the AMS side with the seamline

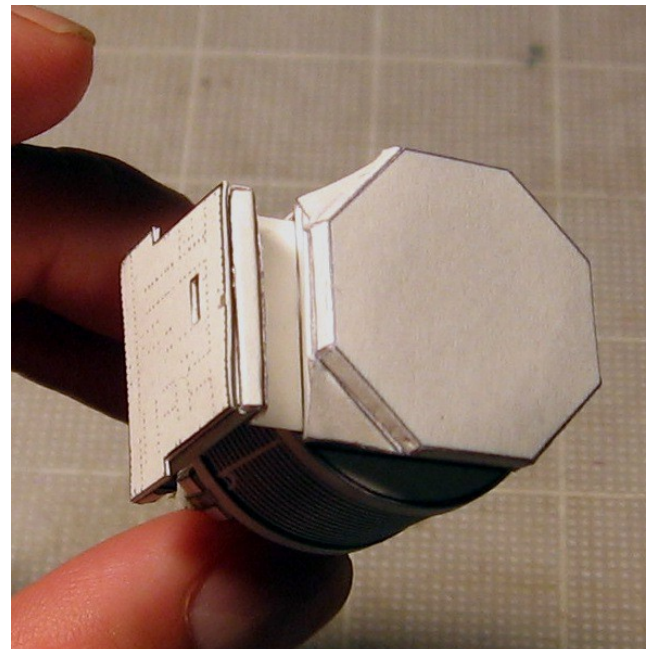
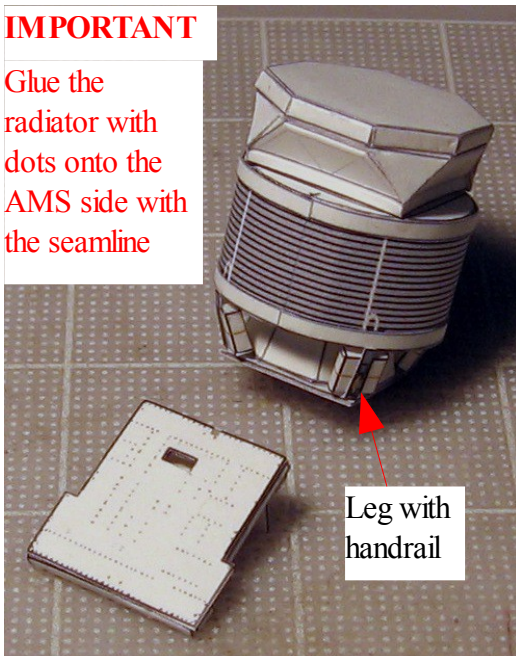



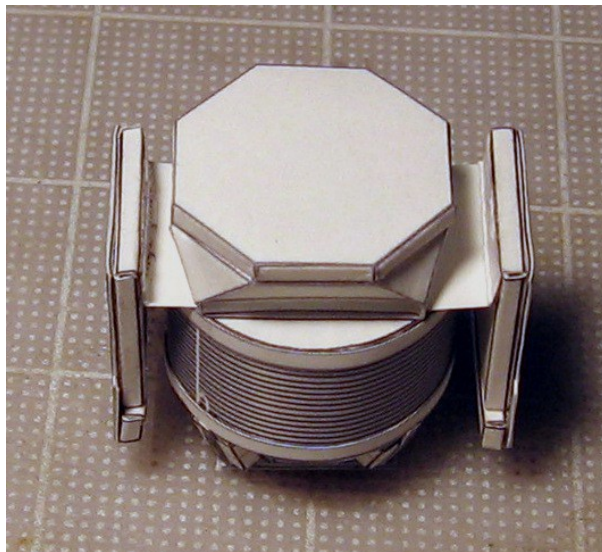

**IMPORTANT BEFORE GLUING LEGS:** Diagram shows the relationship between the radiators and the AMS legs

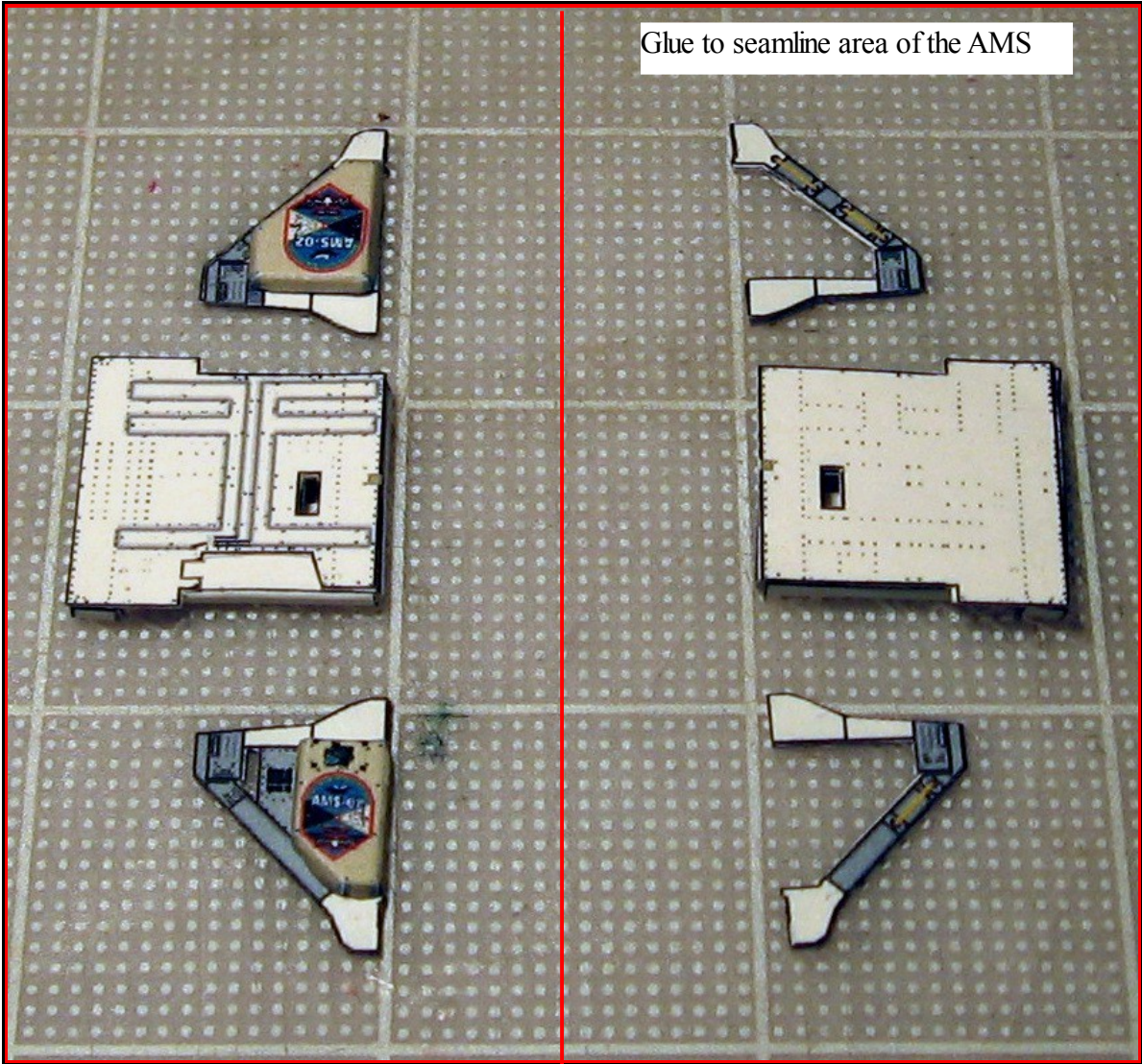



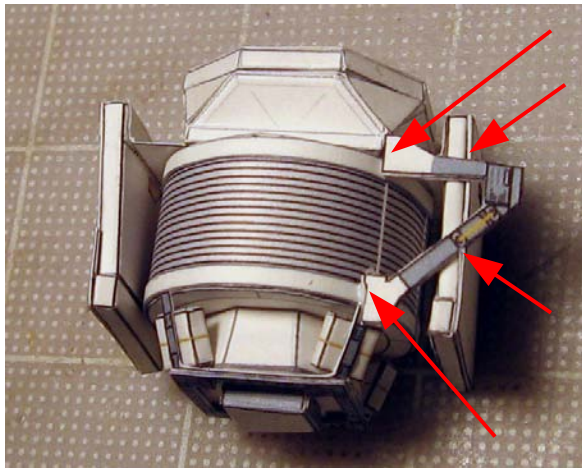

When gluing the legs be very careful keeping the radiator vertical at all times and parallel to the AMS body.  
The arrows indicate where the legs are glued to the AMS body and radiator.

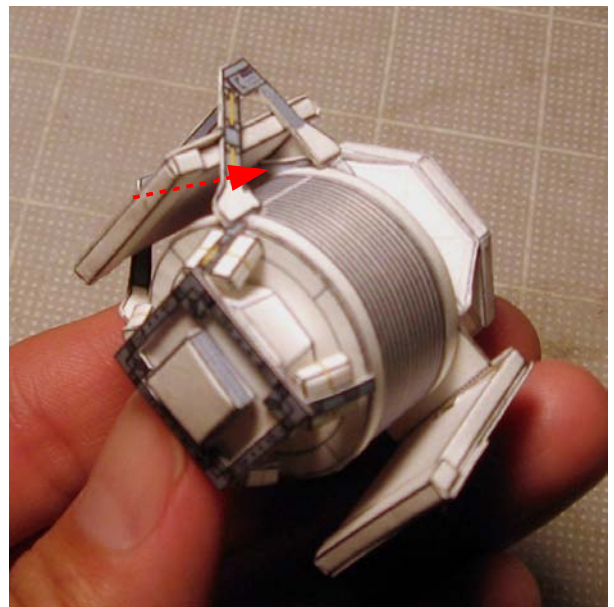
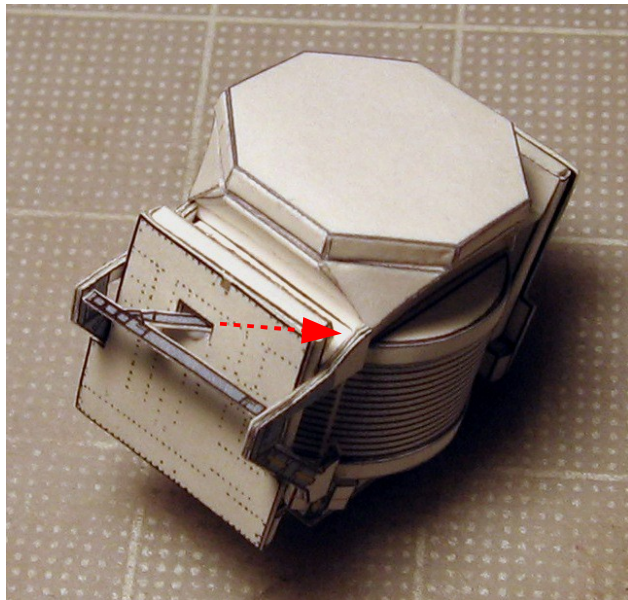
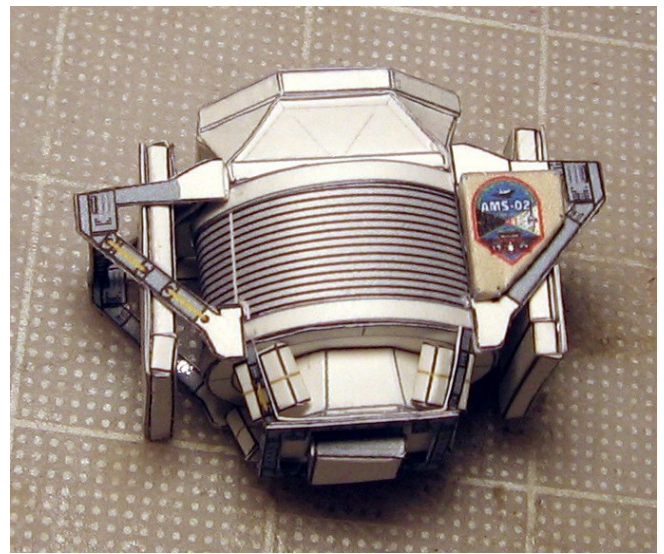
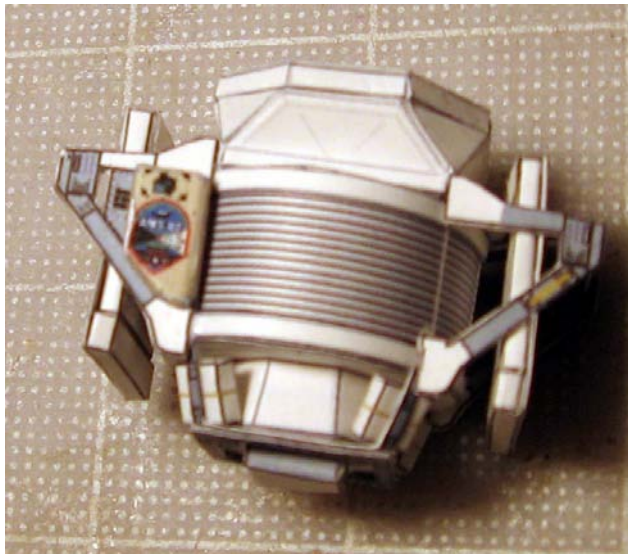



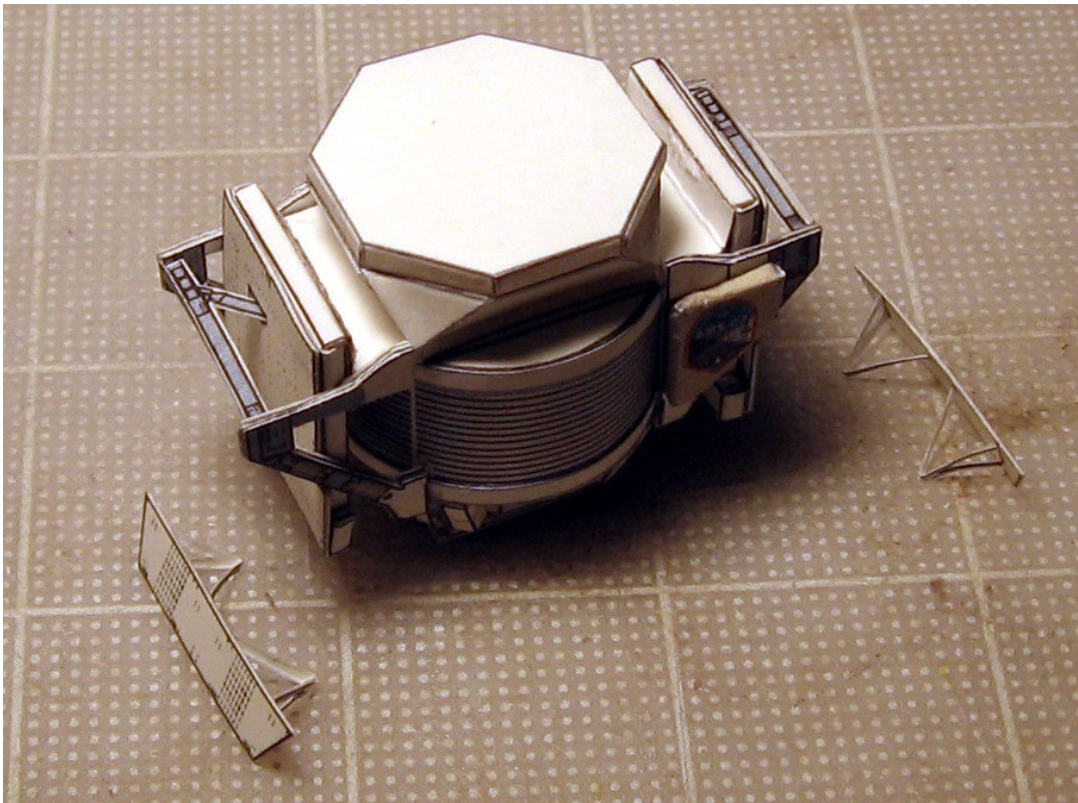
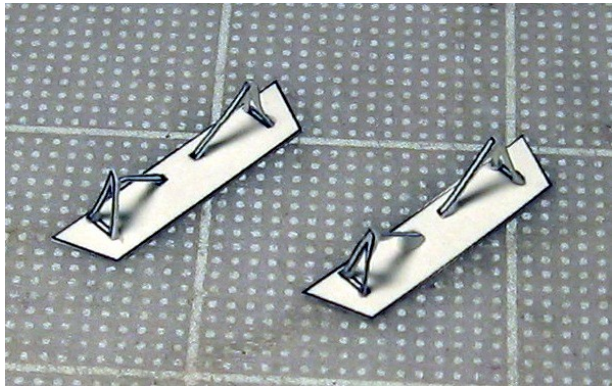
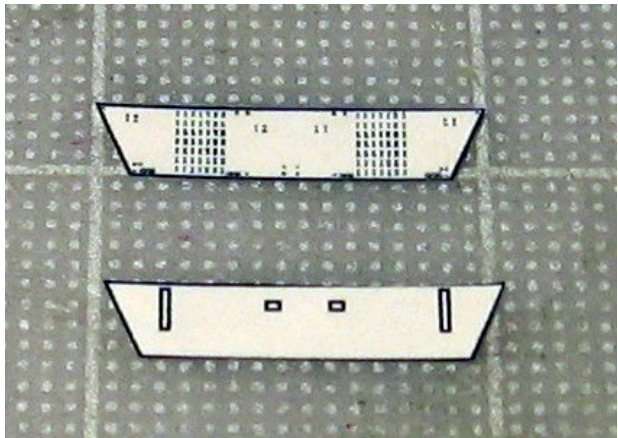
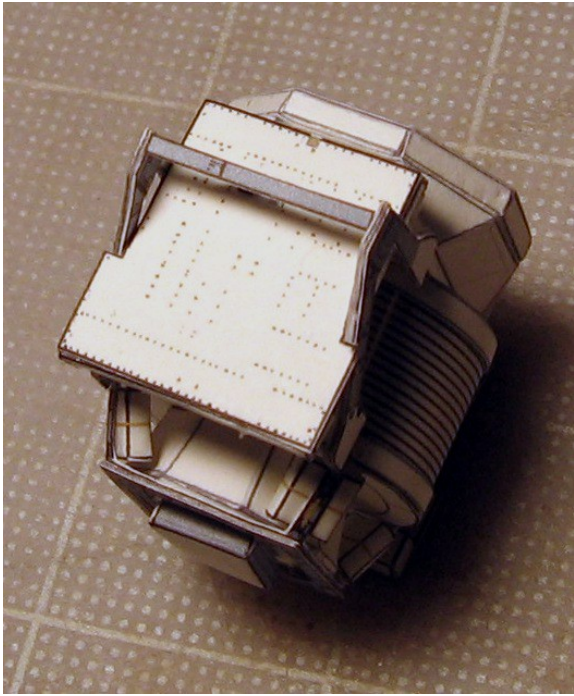



Glue AMS logo top

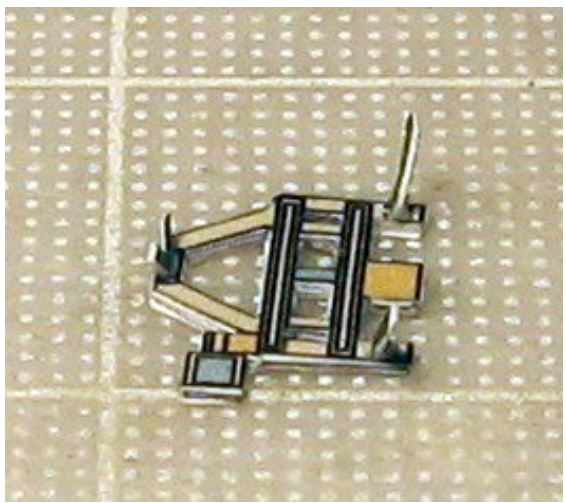
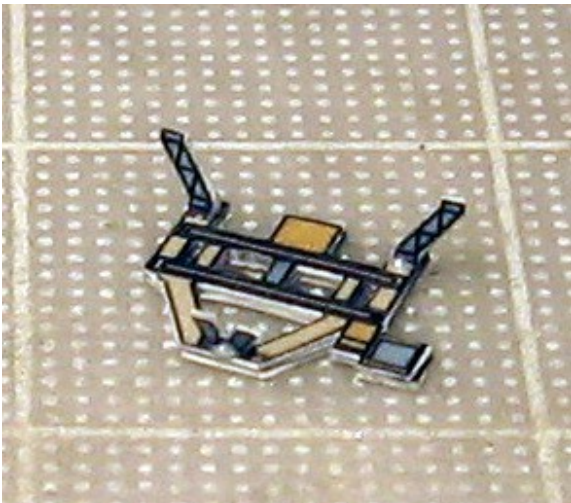
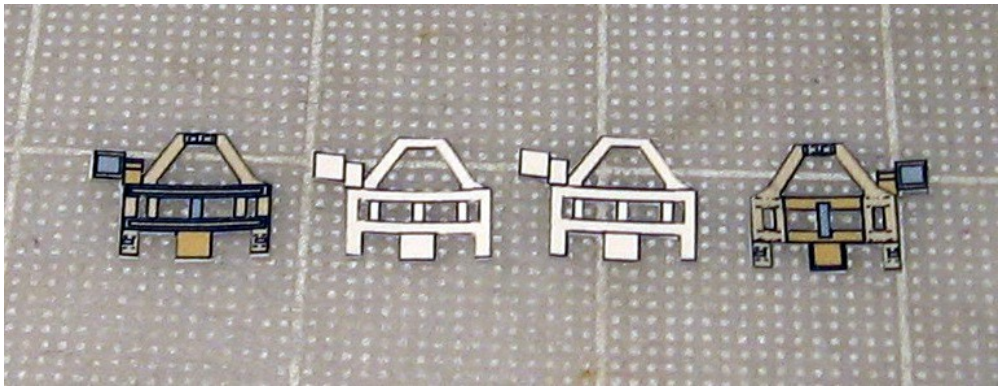
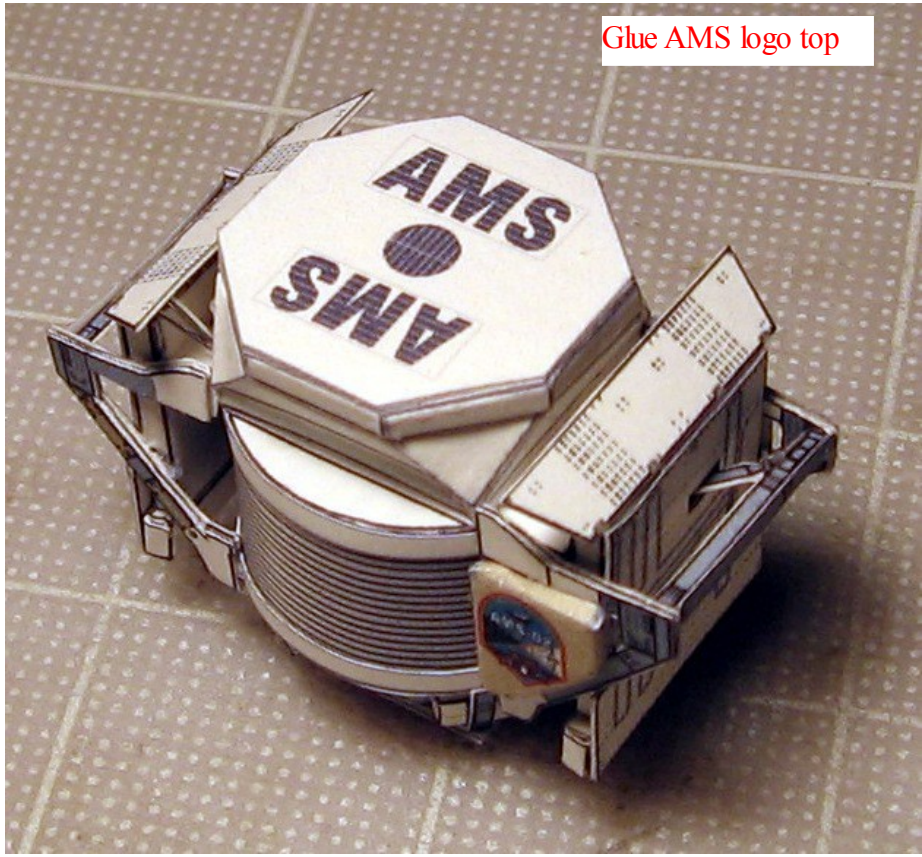



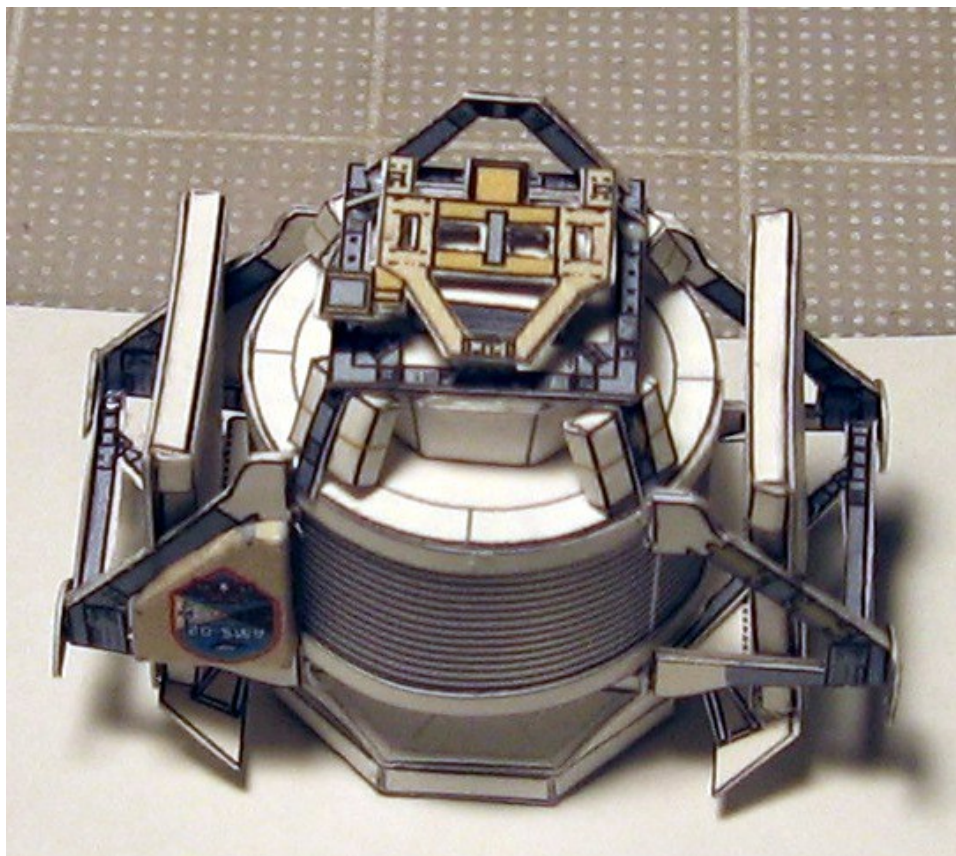
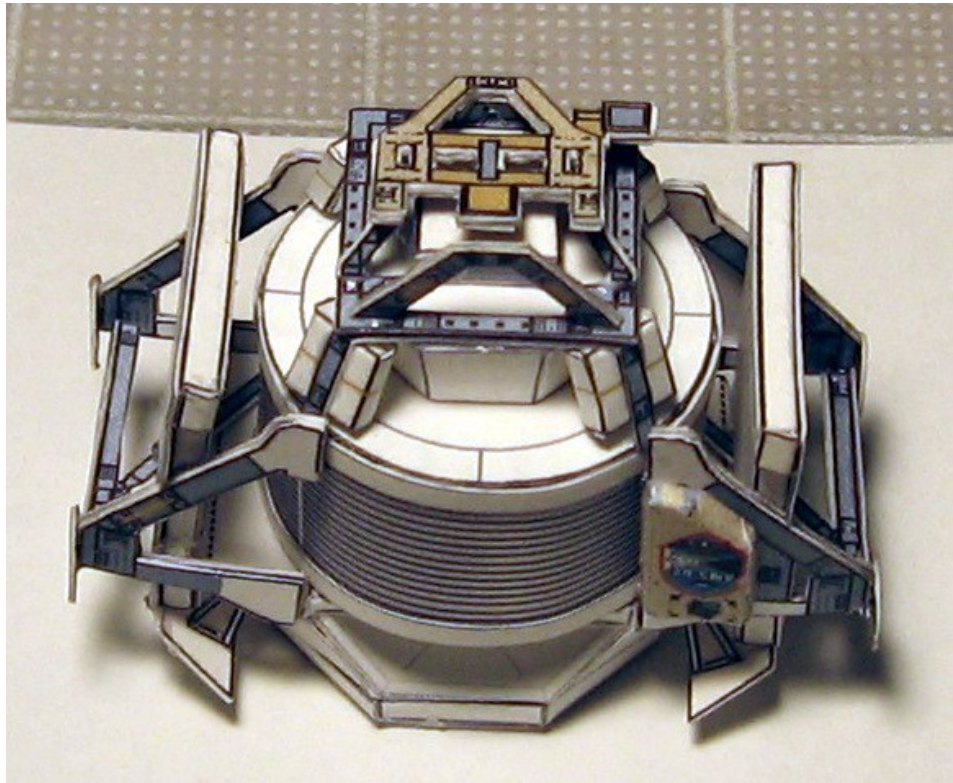



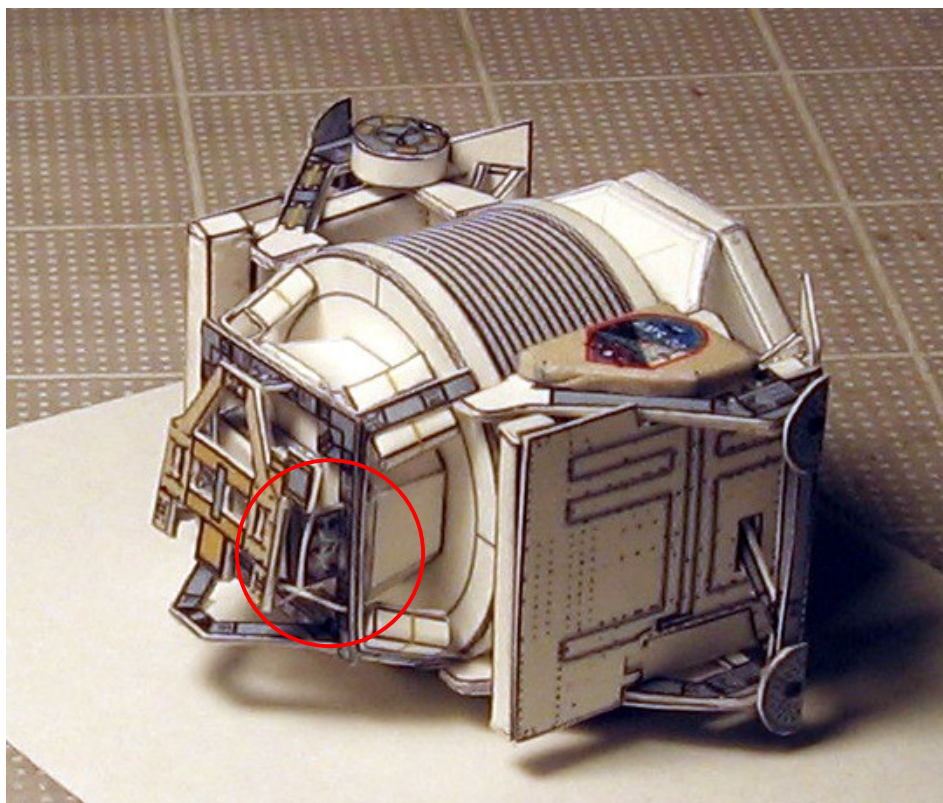
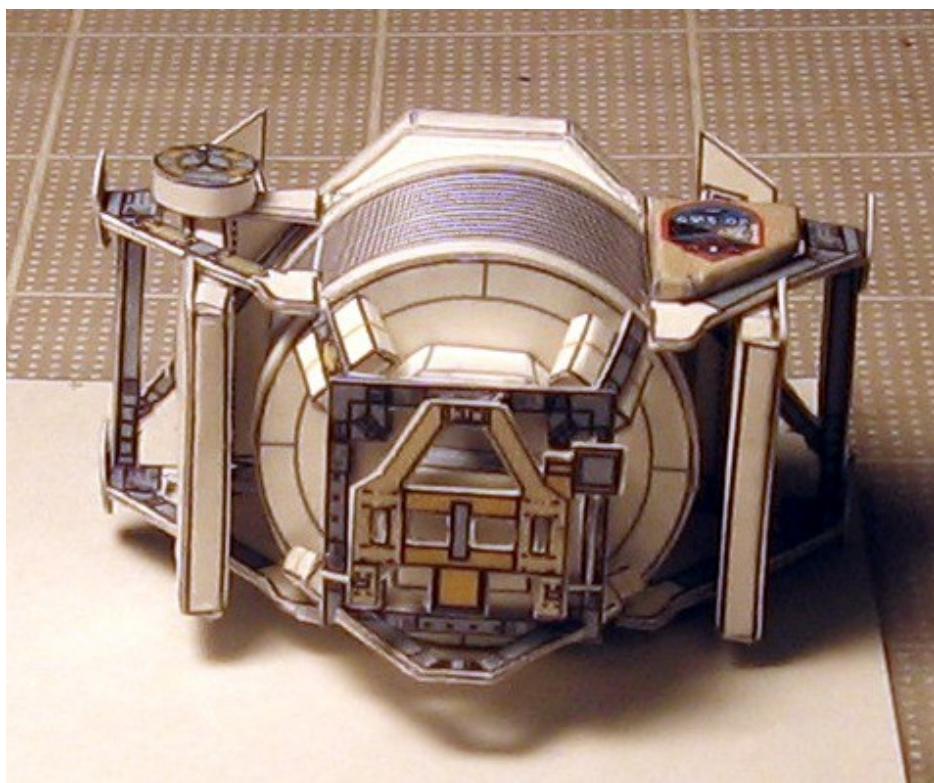



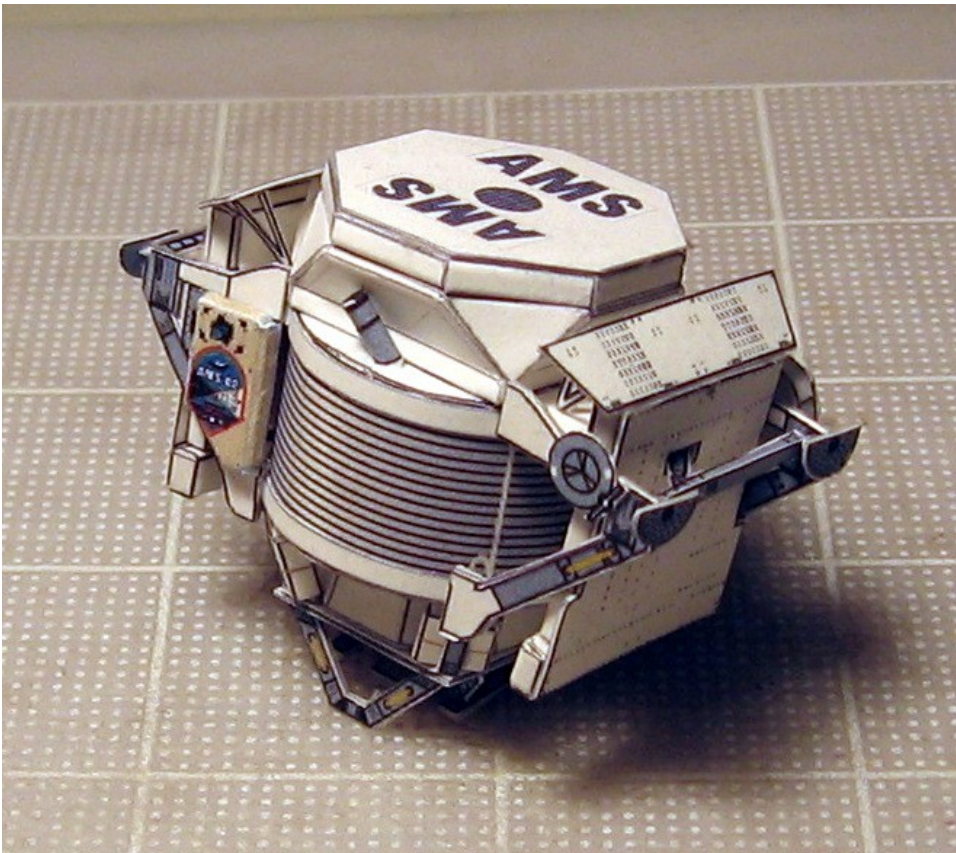
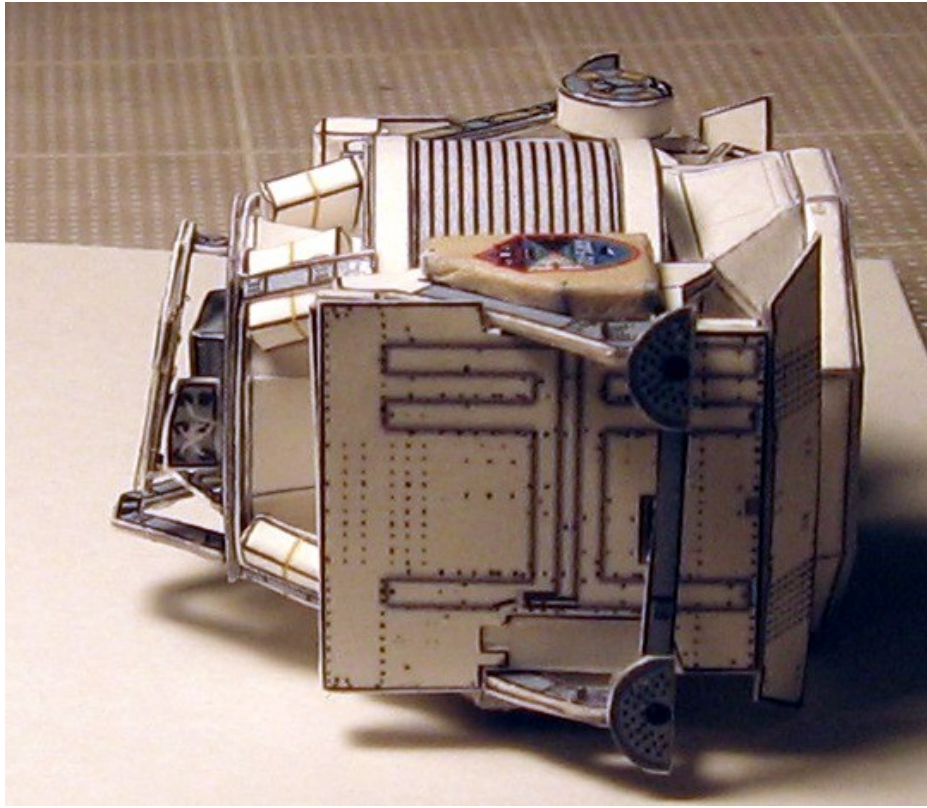



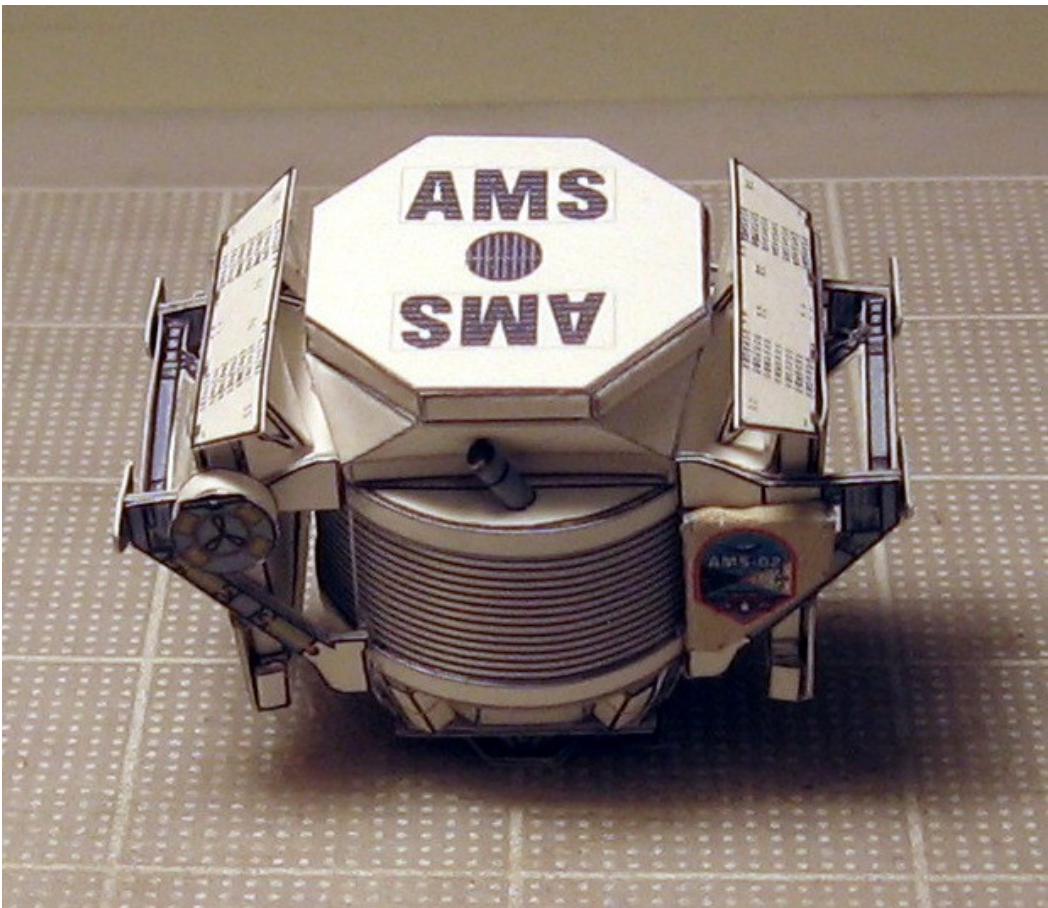
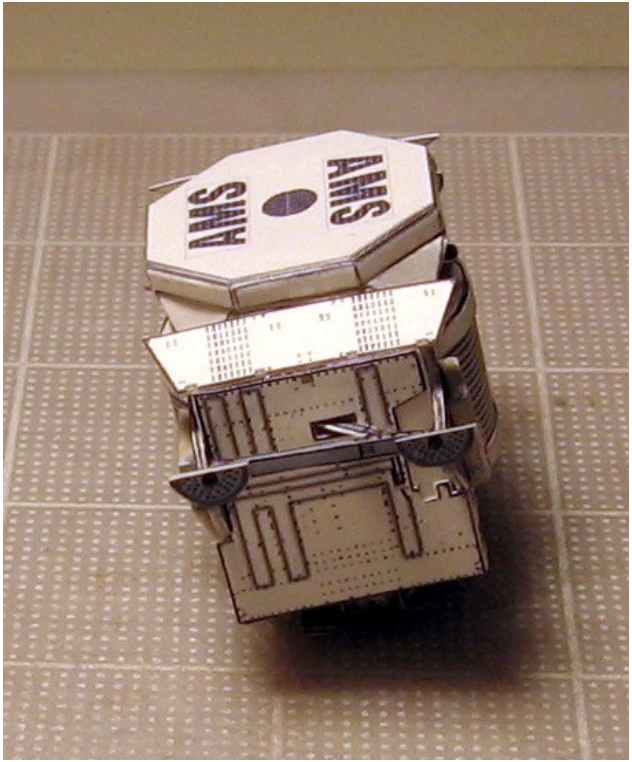
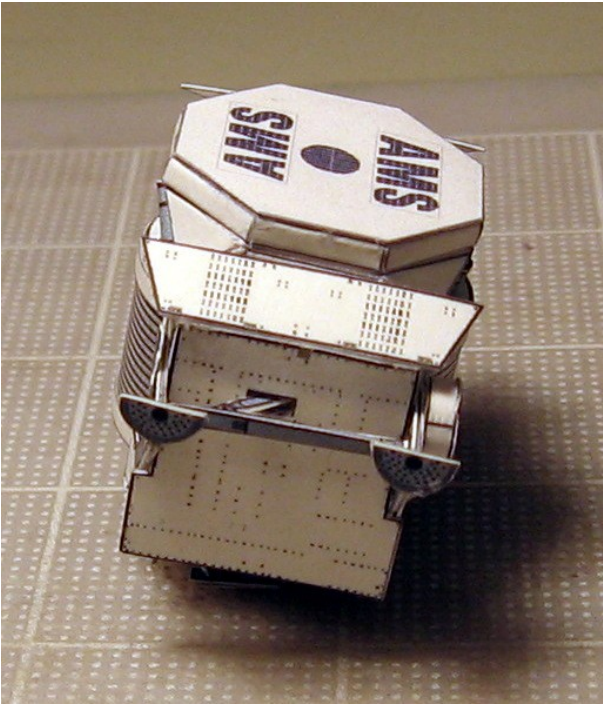



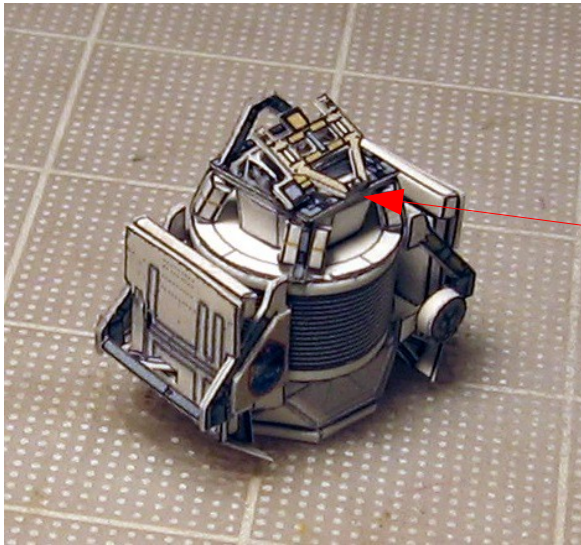

For the 1:144 scale version, the small front “V” shape part that holds the front of the attachment system has been deleted from the file because it is too small.

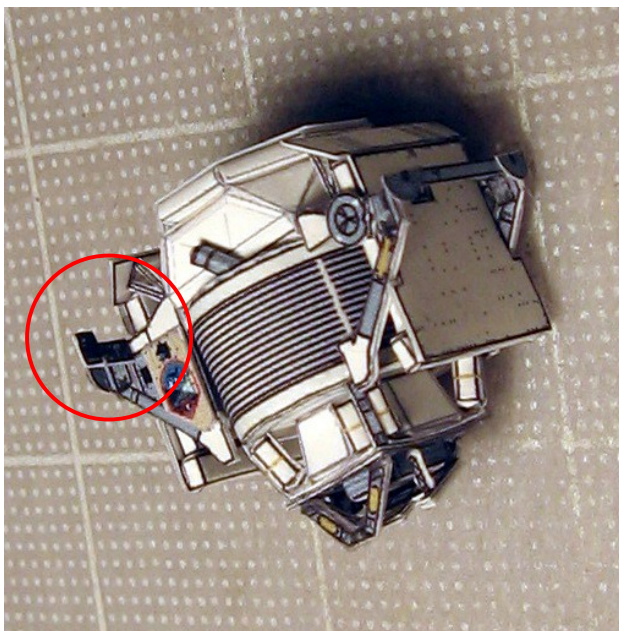
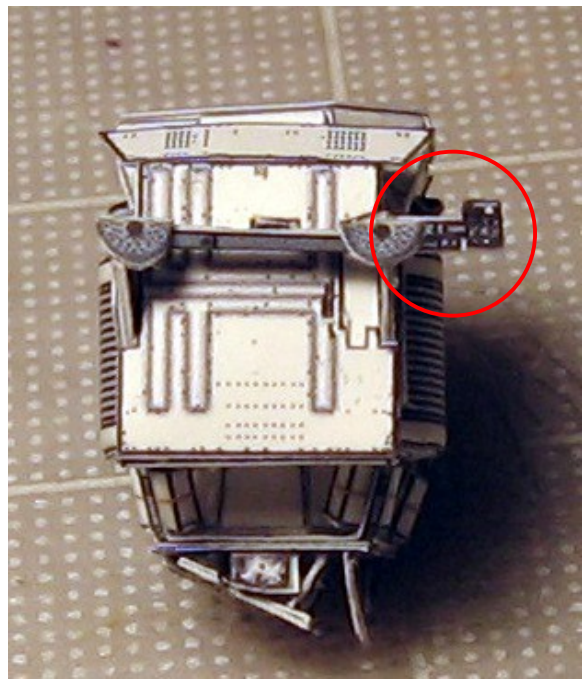
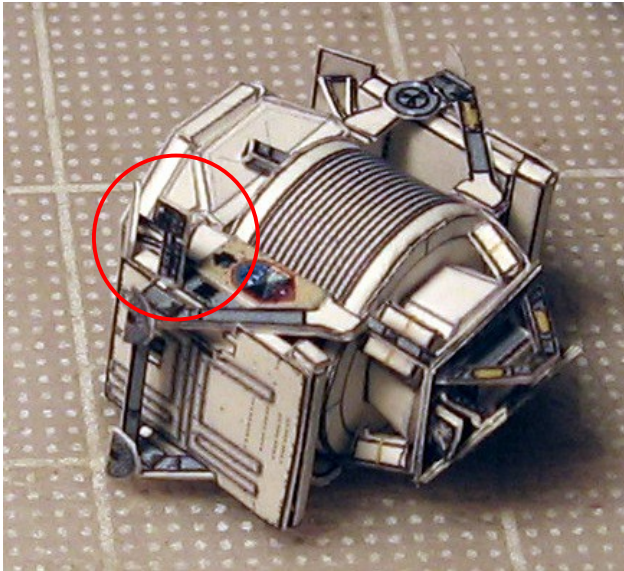

The circles indicate the umbilical that connects to the ROEU on the payload bay.



## Building the OBSS supports for the ISS truss

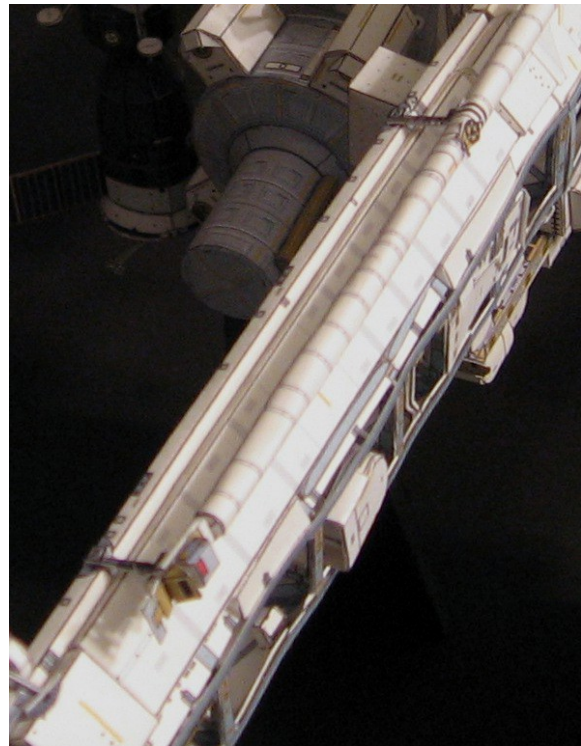
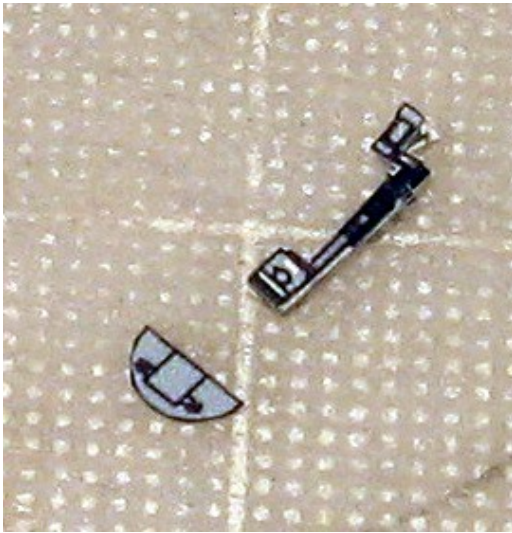

**Important tip:** the OBSS supports are glued to the truss first. Once they have dried, then the OBSS boom is glued.

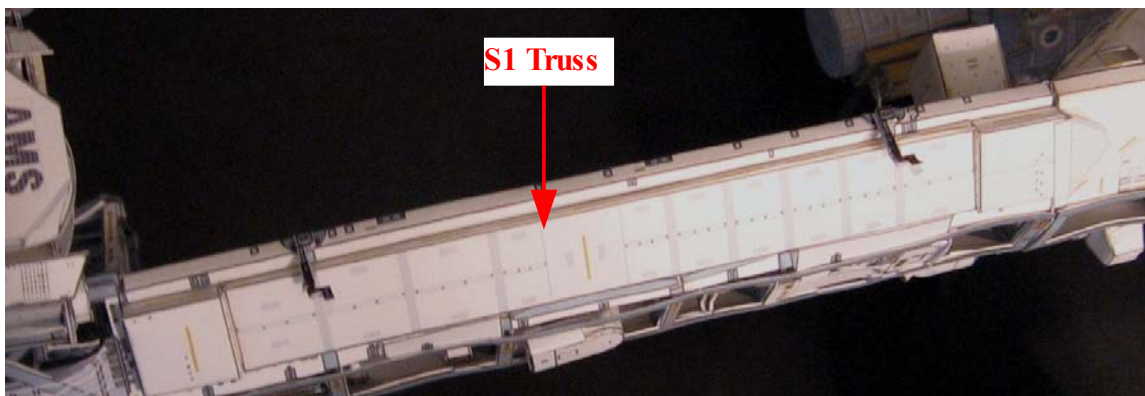



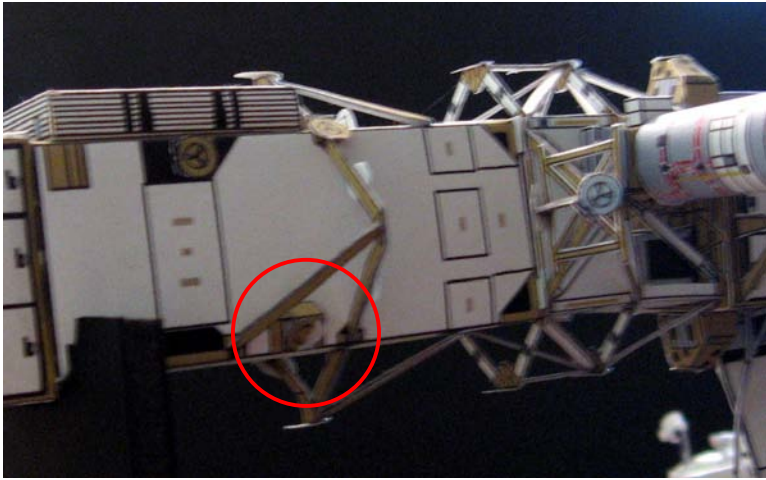

**The PDGF attached to the OBSS boom comes from the P6 truss. The photo shows the location on the back of the P6 truss where the PDGF was removed. To be more accurate with your ISS model, detach the PDGF from your P6 truss and if still in good condition glue it to the tip of the OBSS boom. If not, the STS-134 kit includes a PDGF for the boom.**

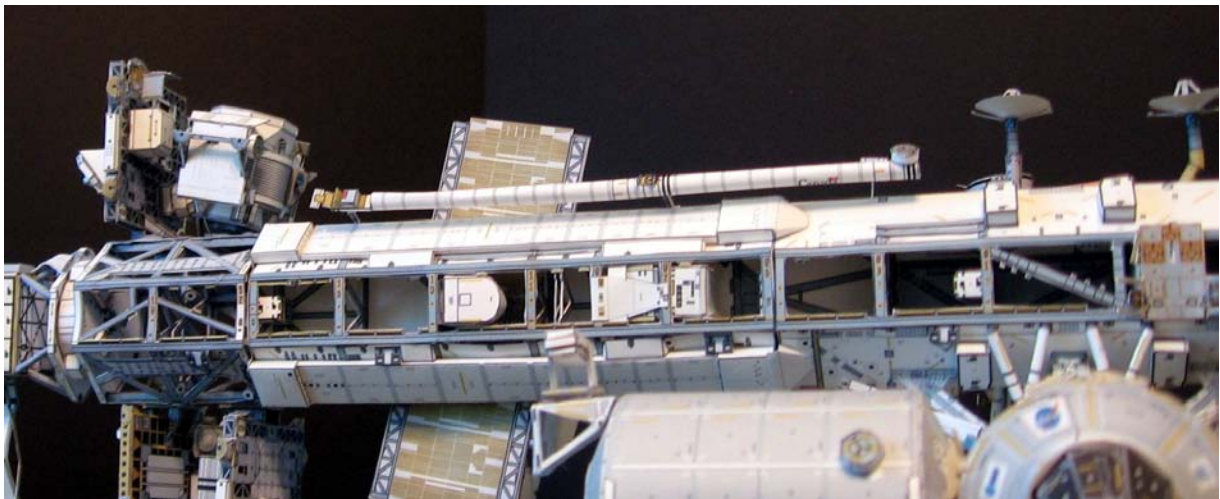
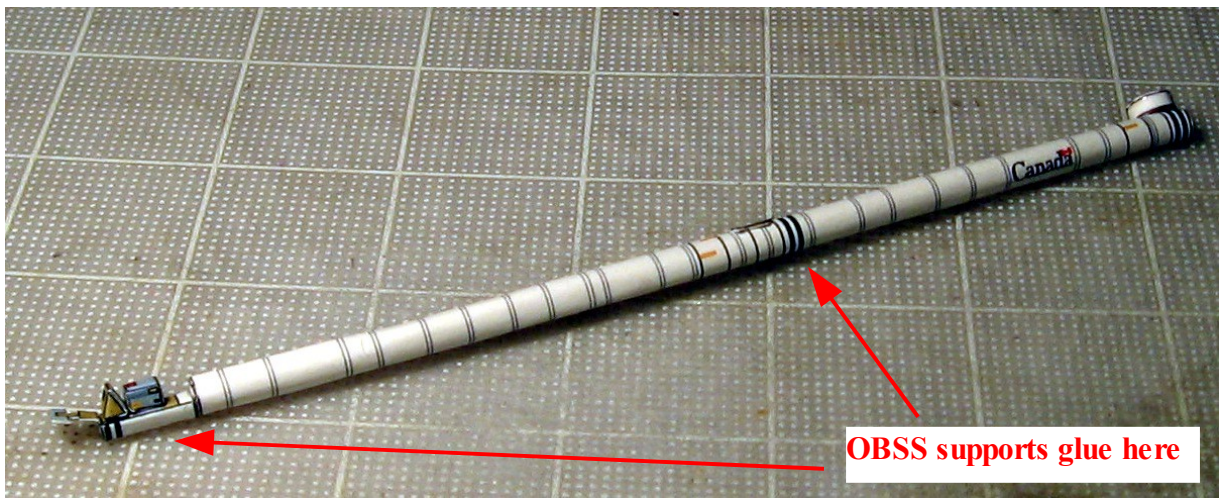



**Attaching the PDGF to the Zarya russian module**





REFERENCE PHOTOS

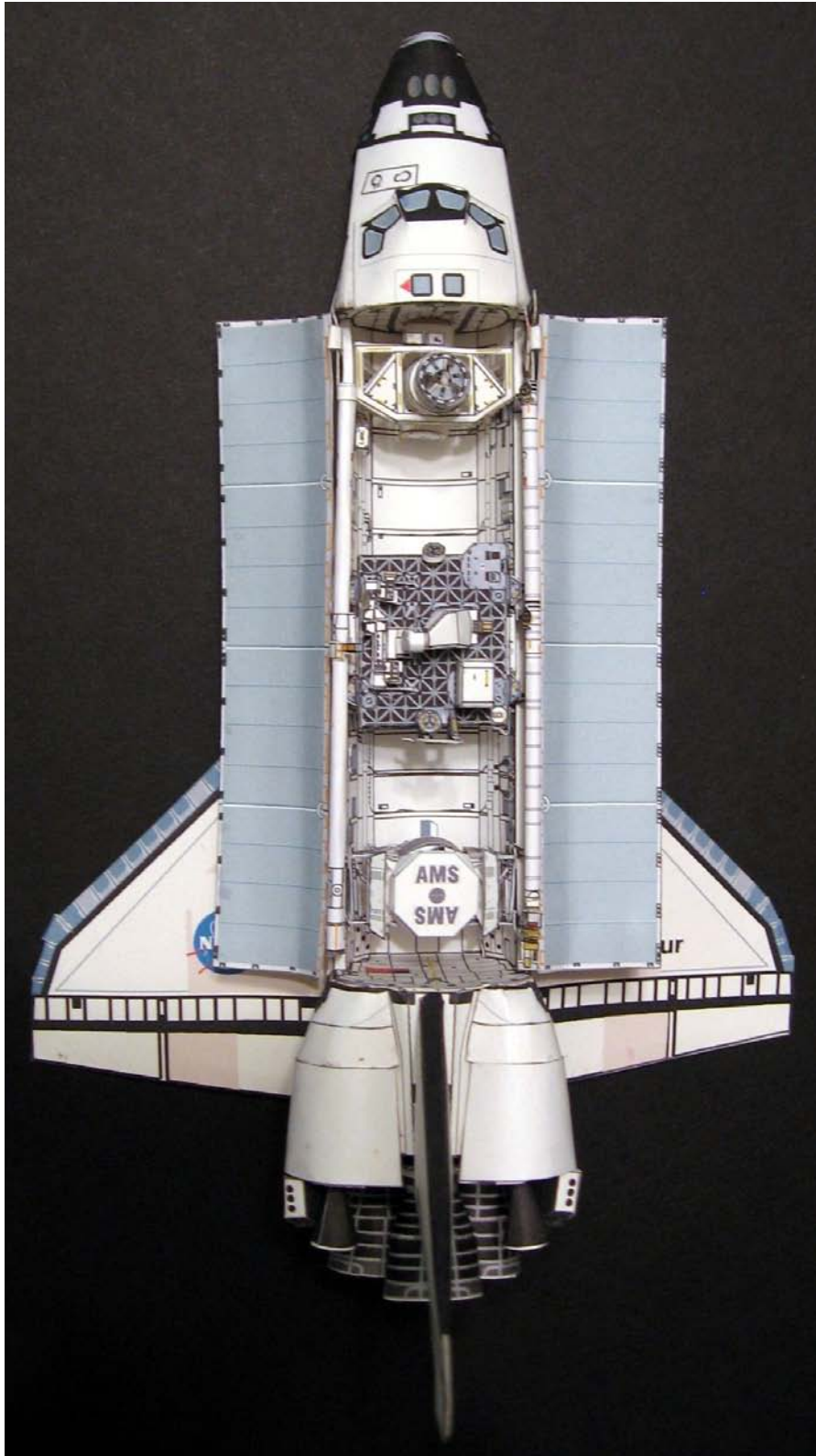



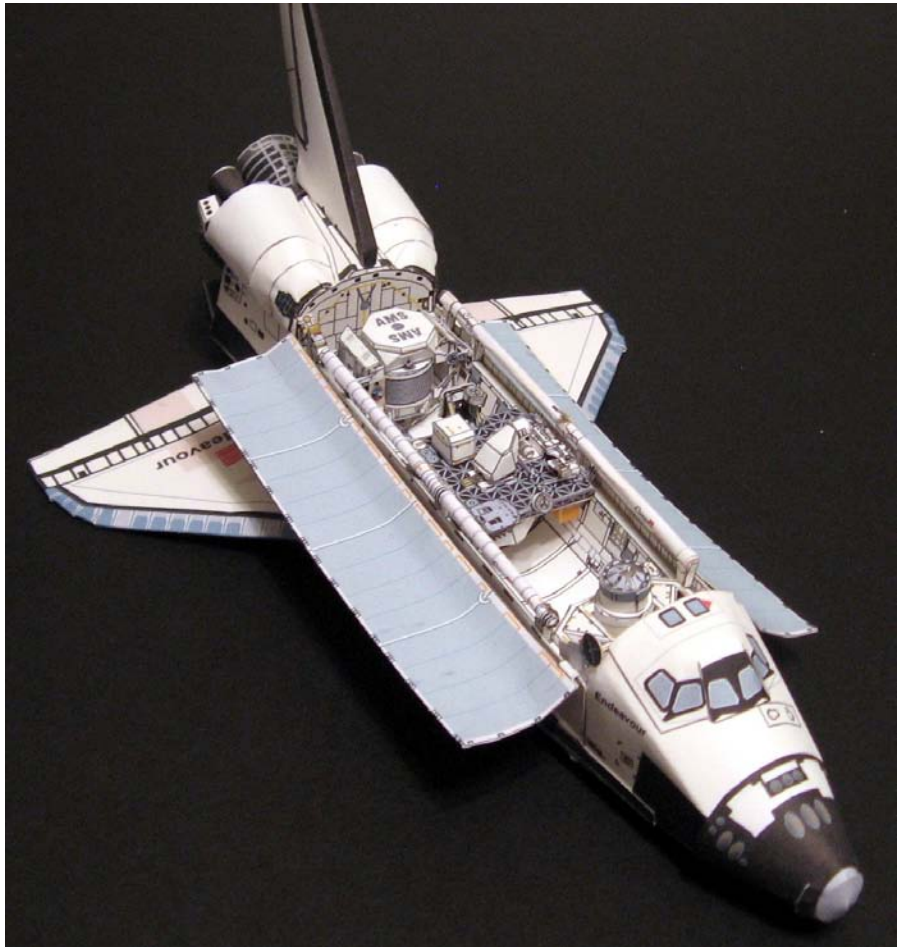
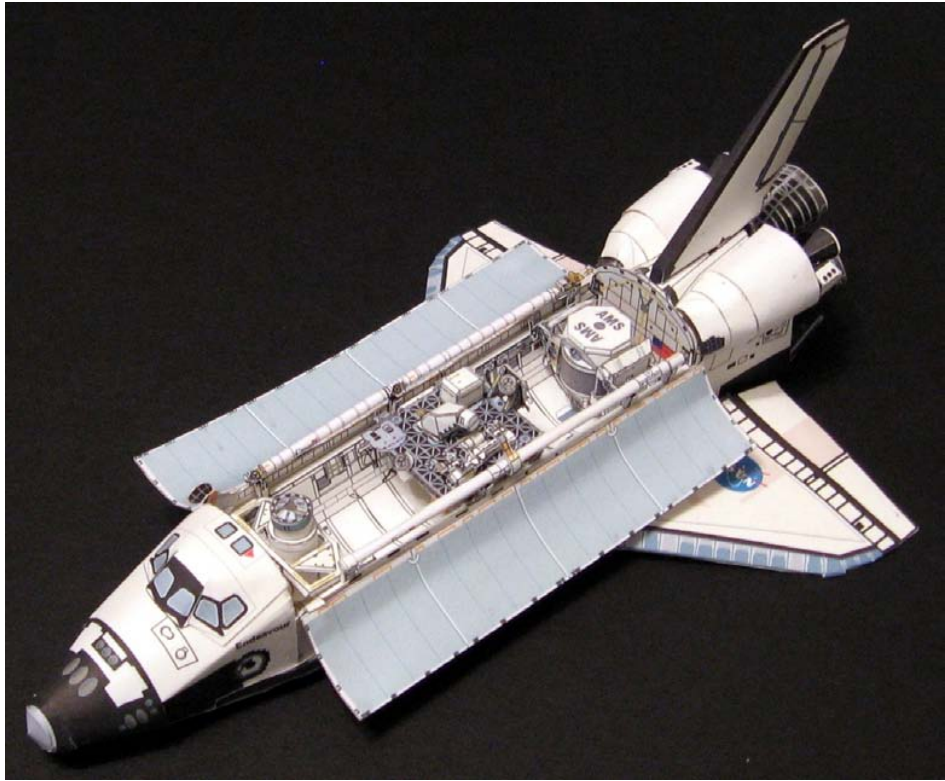



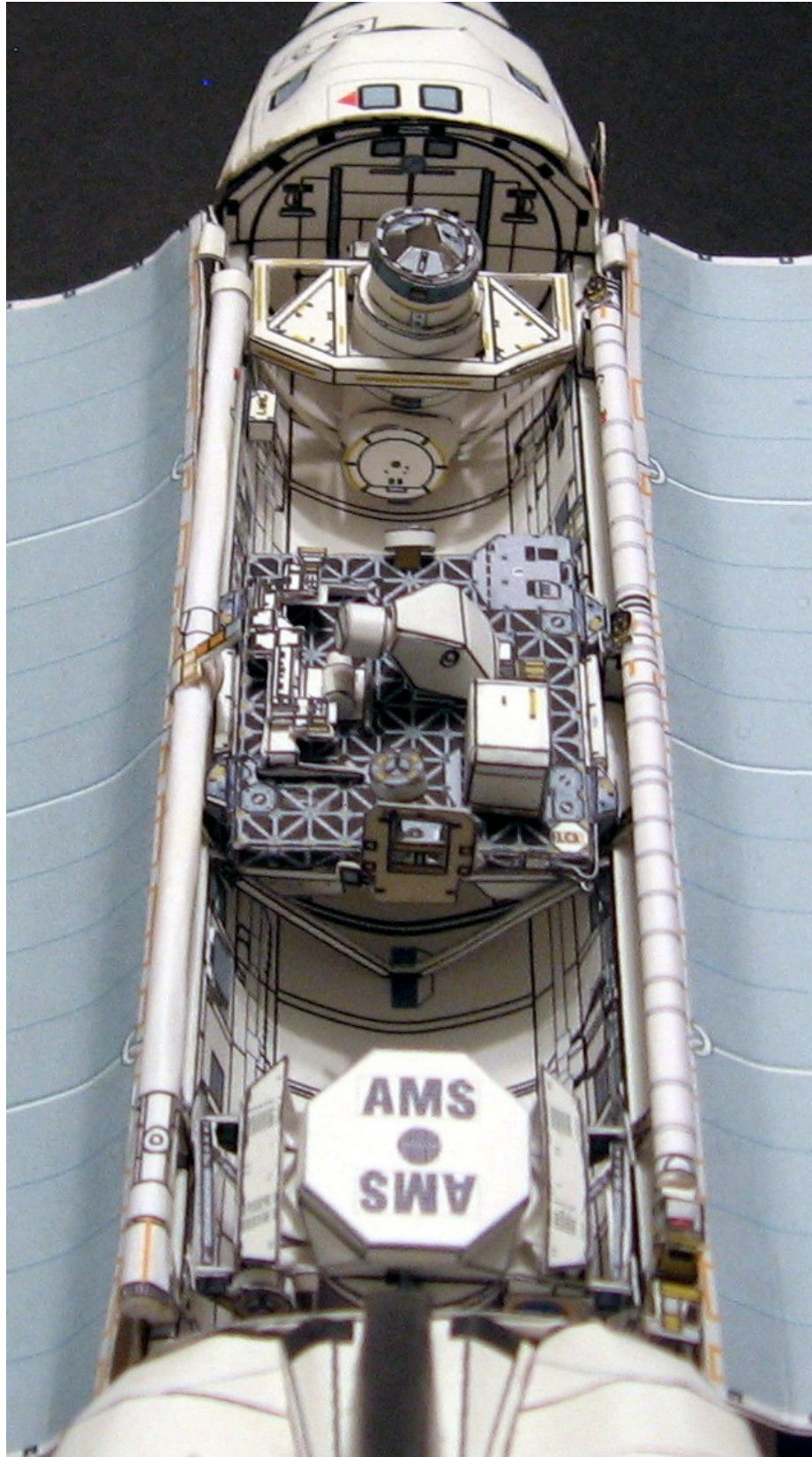



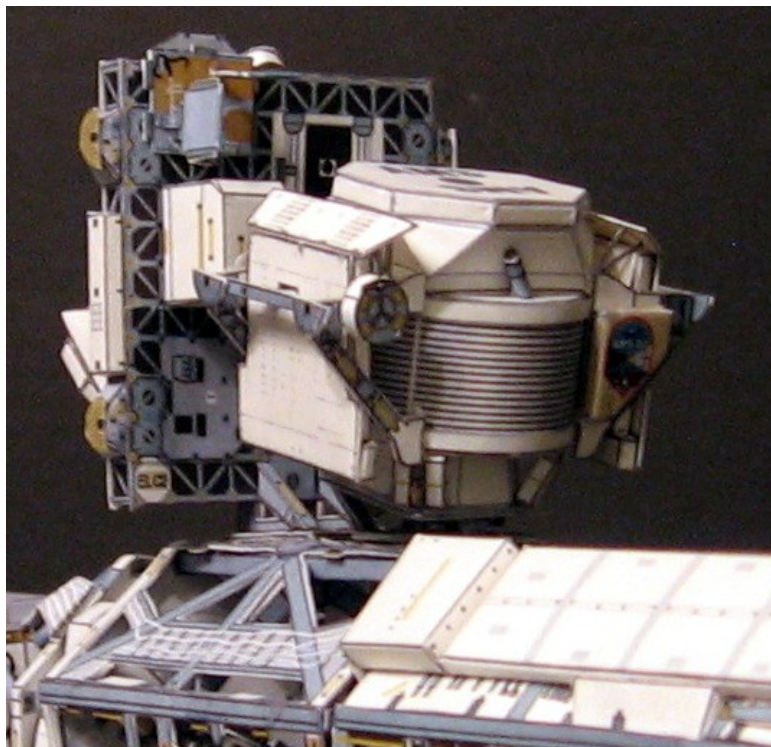
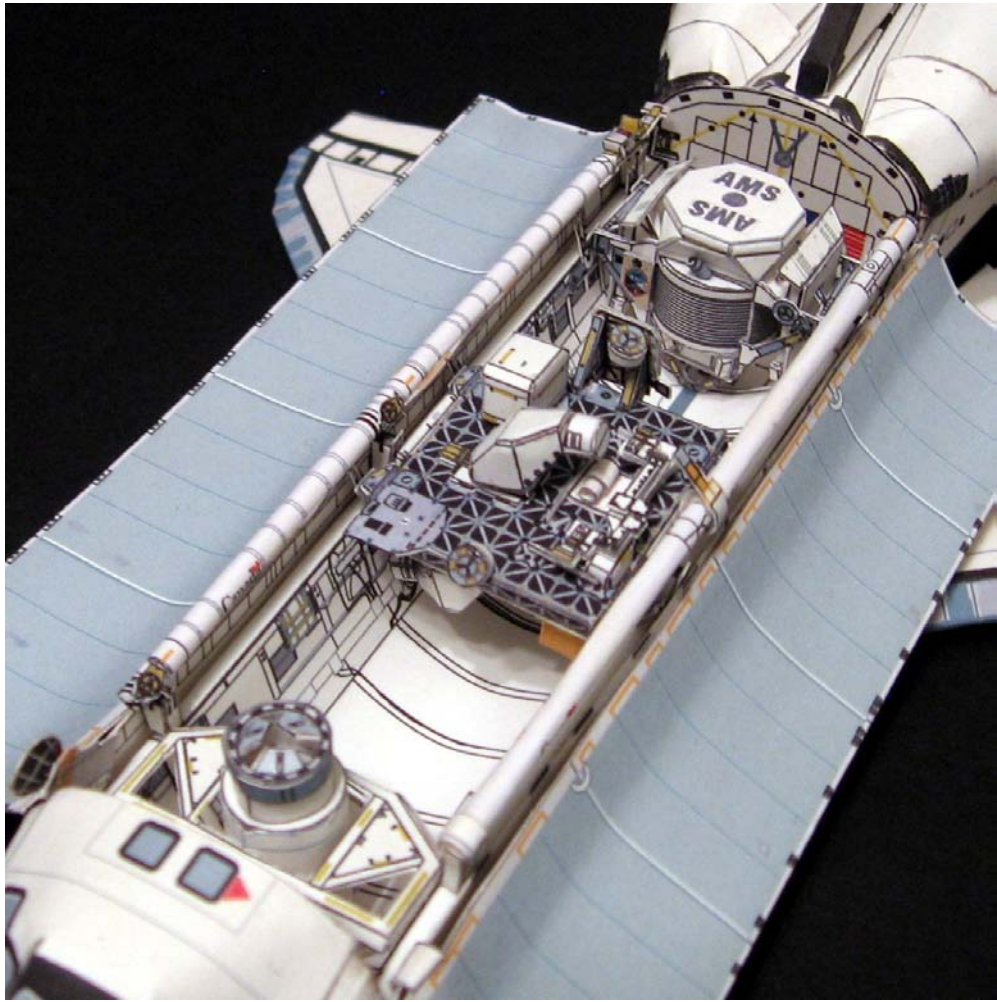



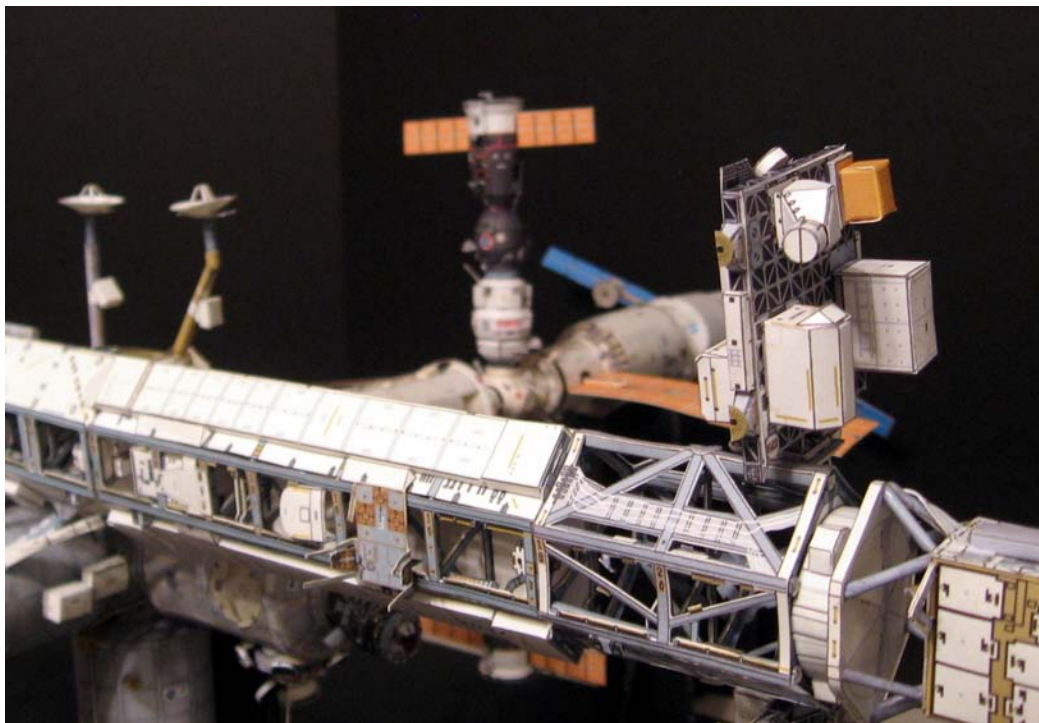
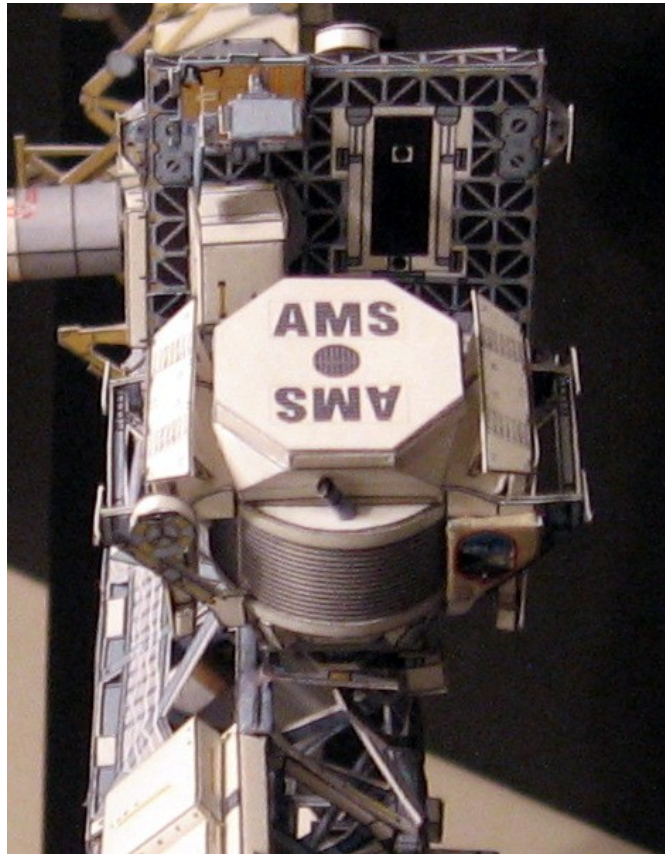

ENJOY THE MODEL!!

<http://www.axmpaperspacescalemodels.com>