



1 cm  
1 inch

Print on Cardstock (110 lbs)

# Zarya

1:100 Scale

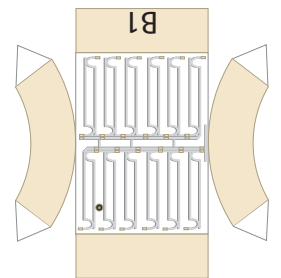
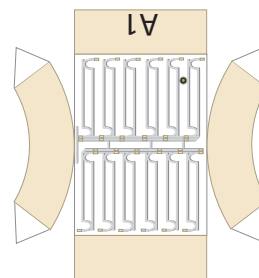
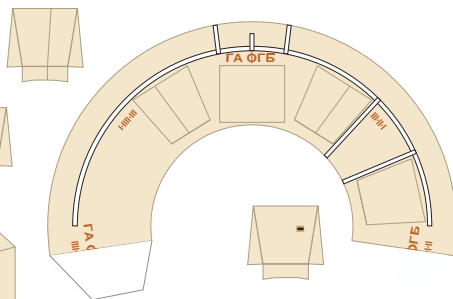
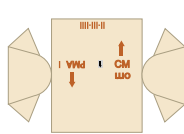
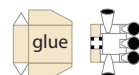
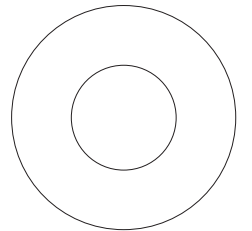
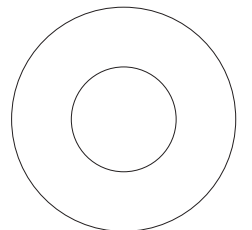
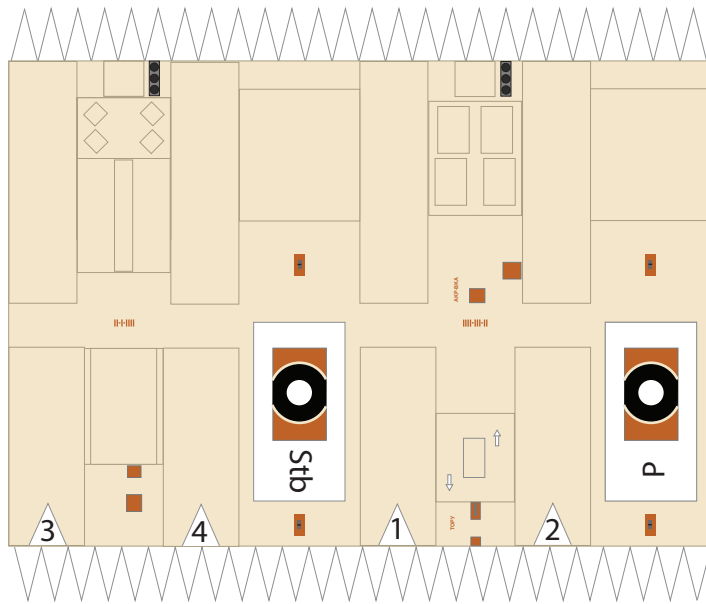
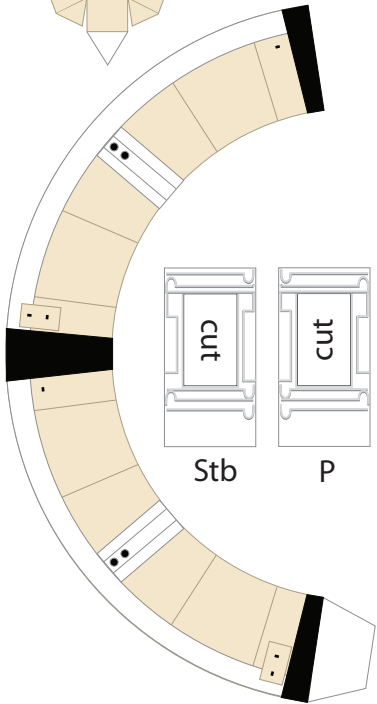
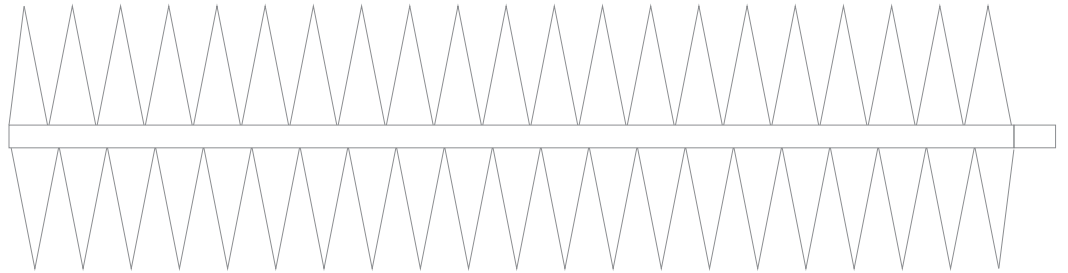
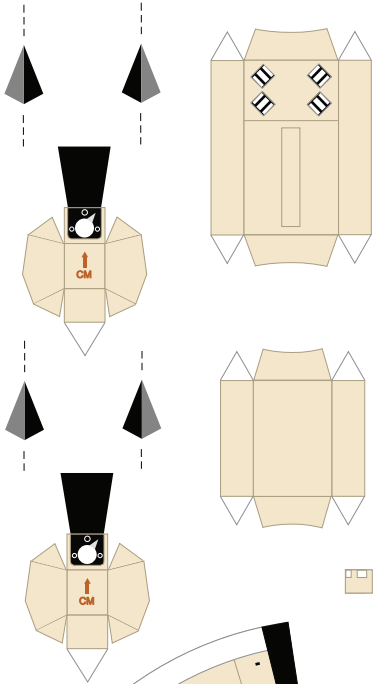
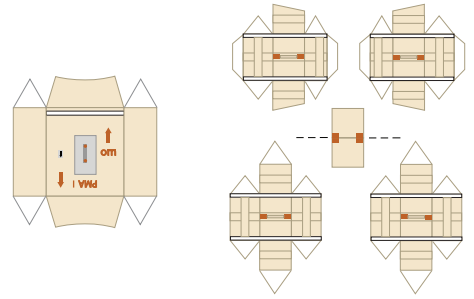
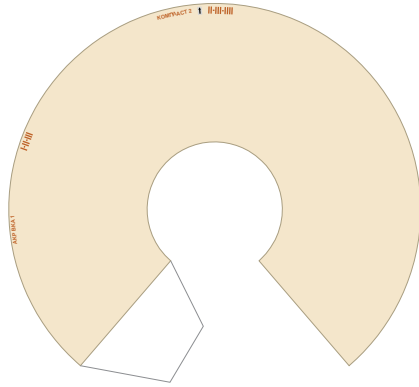



1 cm  
1 inch

Print on Cardstock (110 lbs)

# Zarya

1:100 Scale

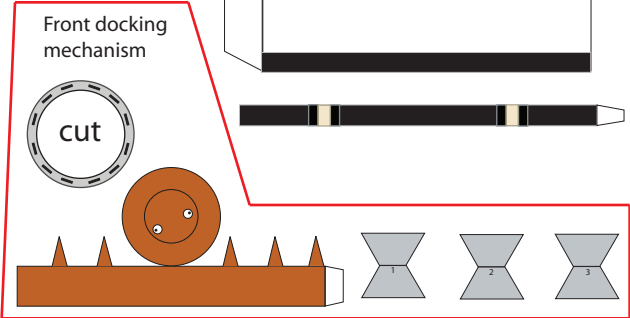
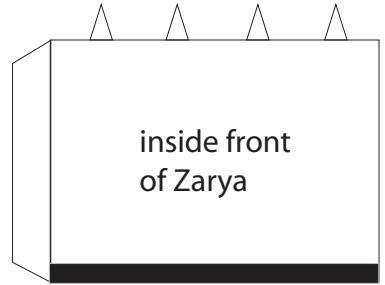
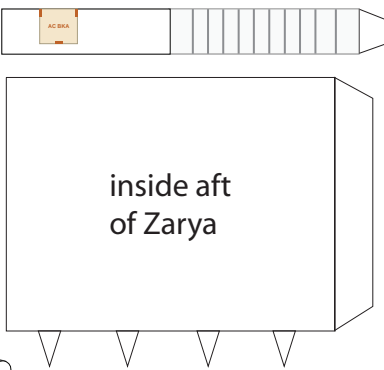
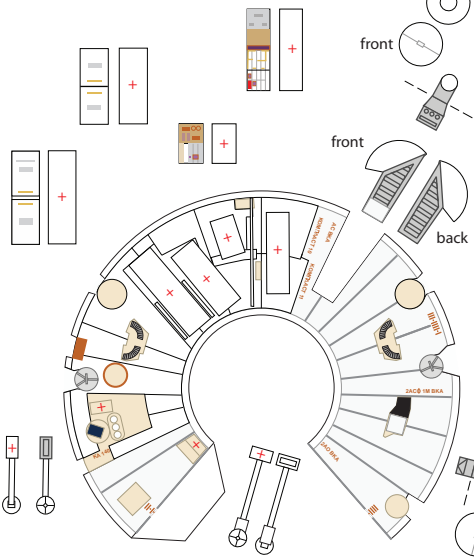
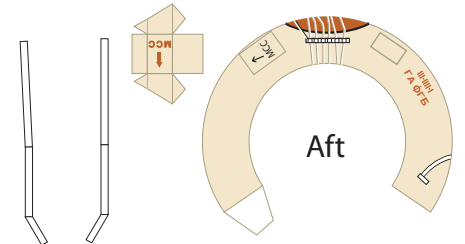
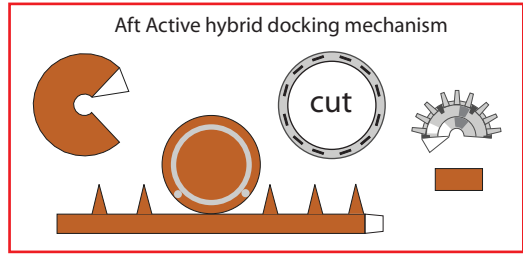
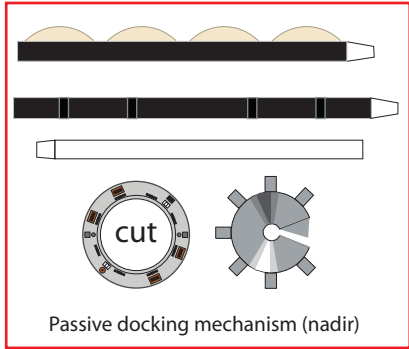
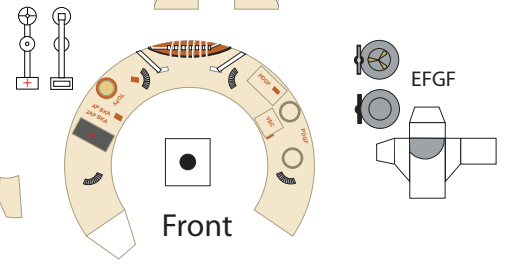
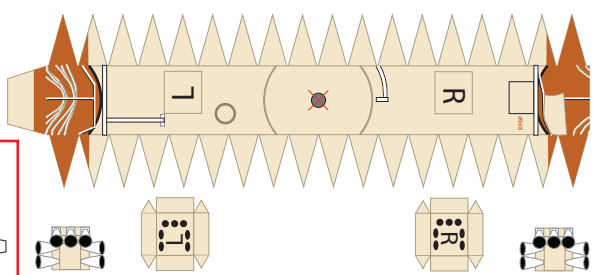
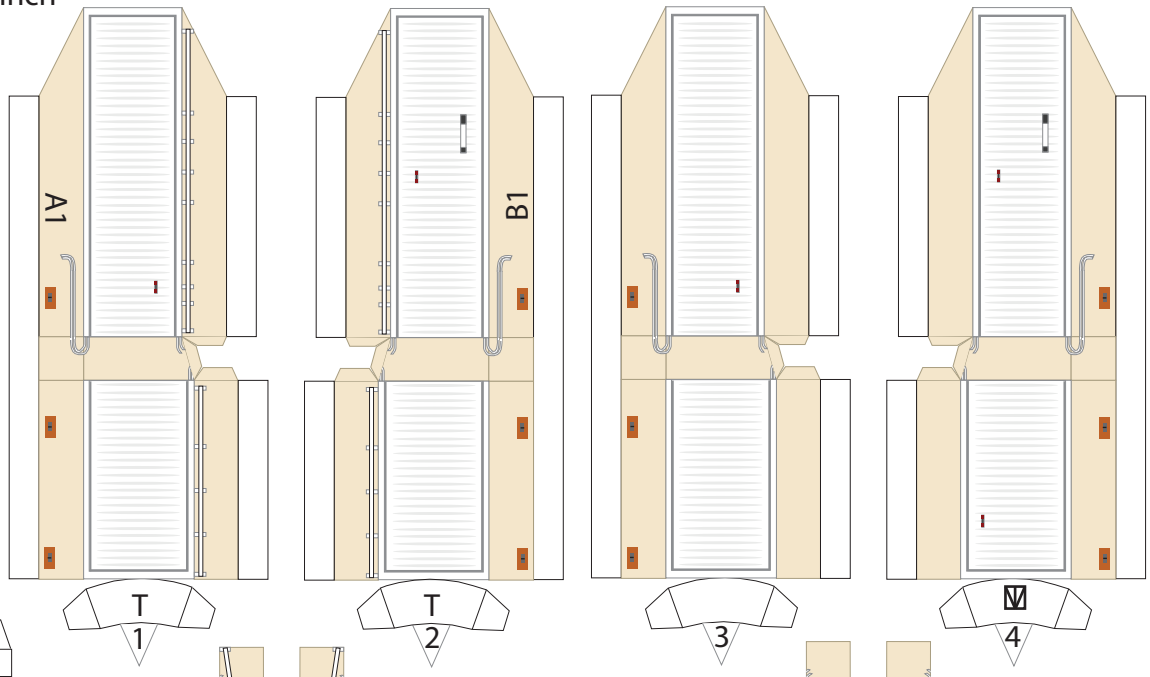
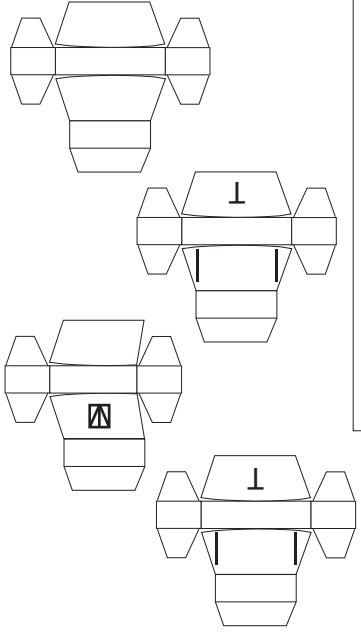
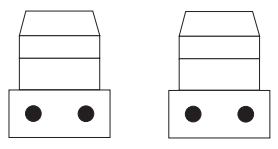



Print on Cardstock (90 lbs)

# Zarya solar panels

1:100 Scale

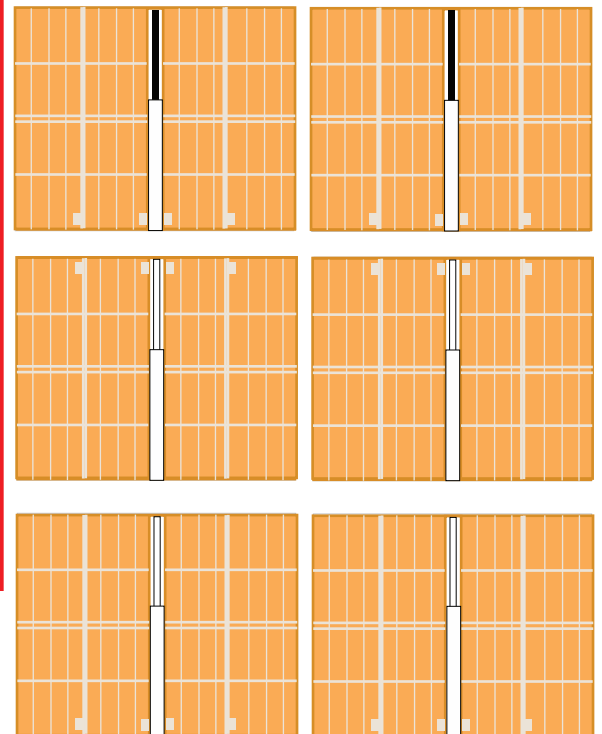
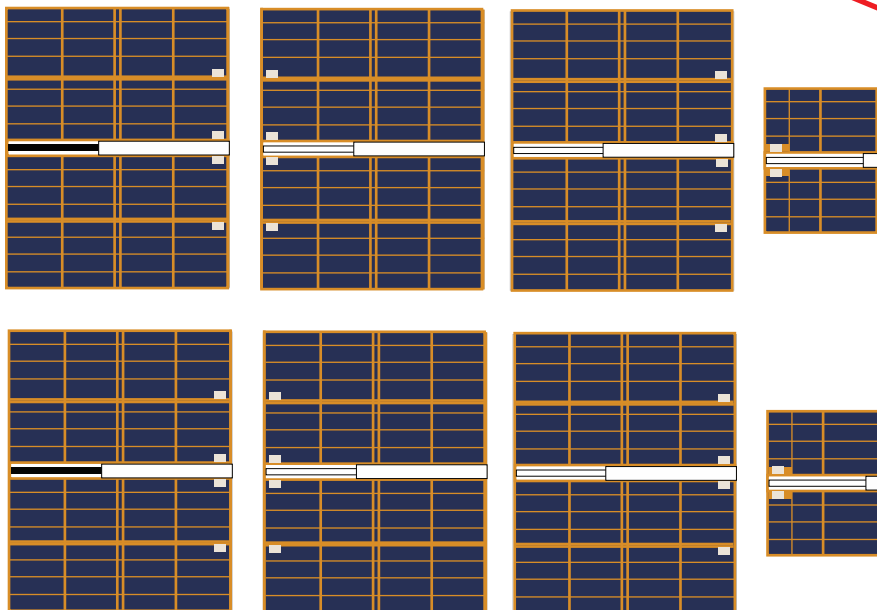
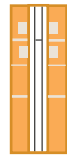
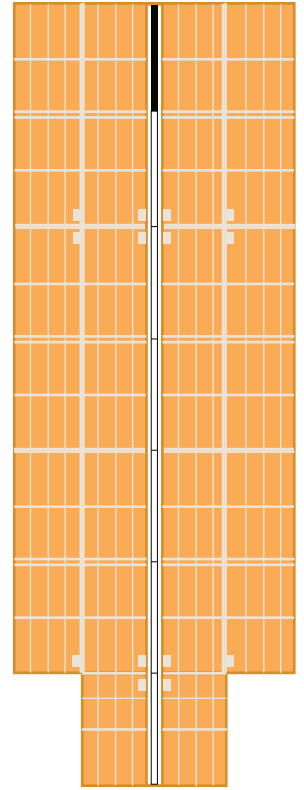
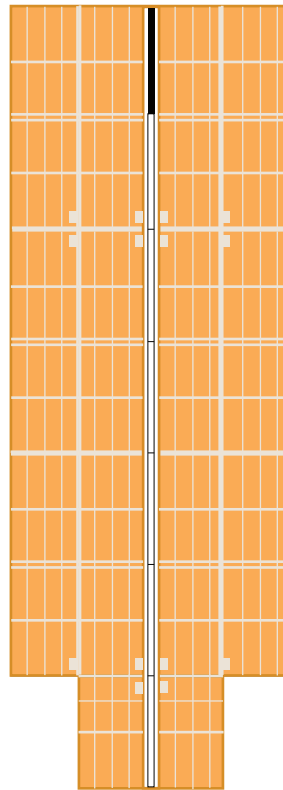
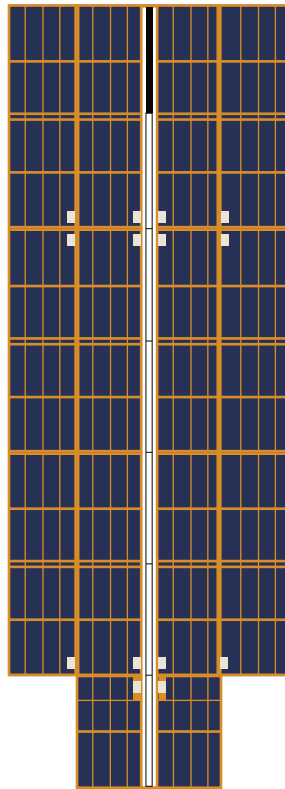
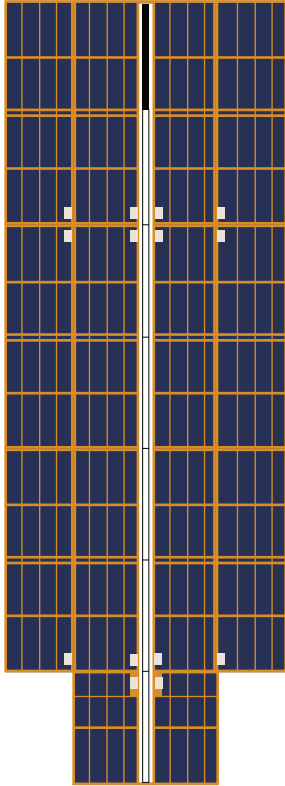

Folded configuration panels

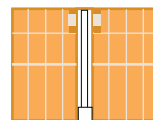
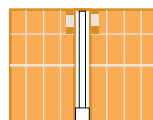



1:100 Scale



Print on Cardstock (110 lbs)

# Zarya

inner

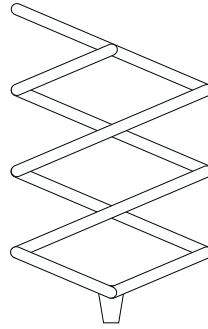

outer

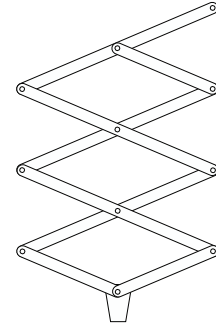

outer

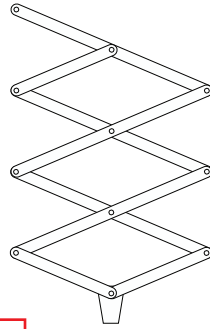

inner

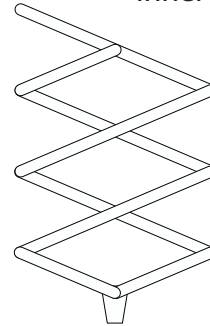

outer

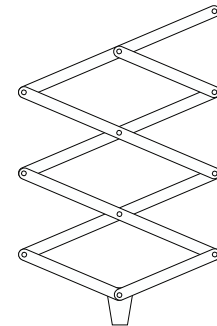

outer

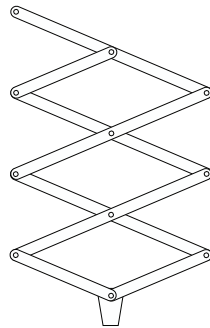

inner

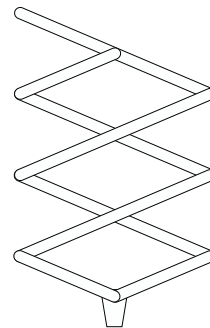

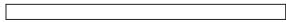

Cut a cottonswab (37 mm of length and 2 mm of width) and use as a connector for the folded wing configuration

