



1 cm  
1 inch

Print on Cardstock (90 lbs)



# Mini Research Module-1 (MRM-1)

## "RASSVET"

1:100 Scale  
Sheet 1

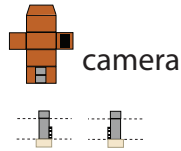

Ring 1

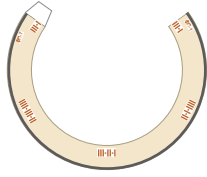

Ring 2



camera

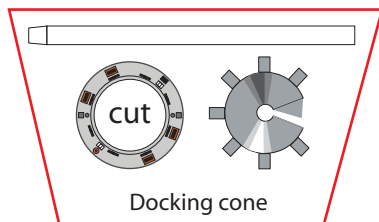
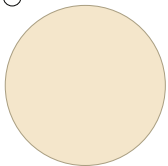
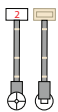
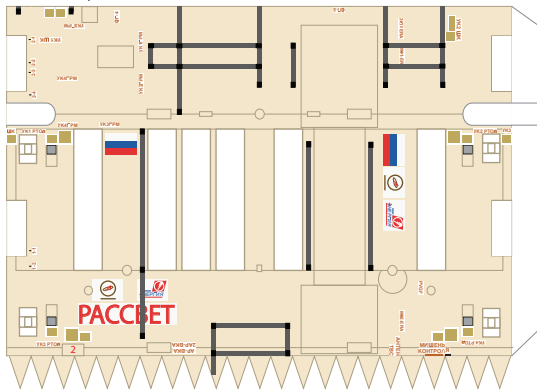

Docking cone

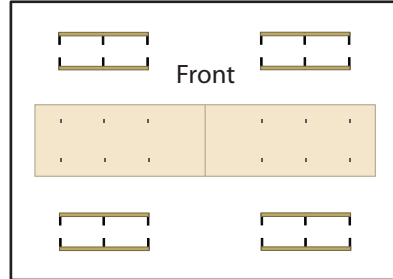

Front

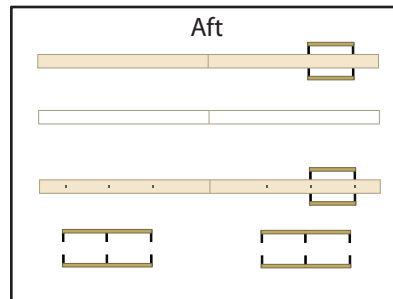

Aft

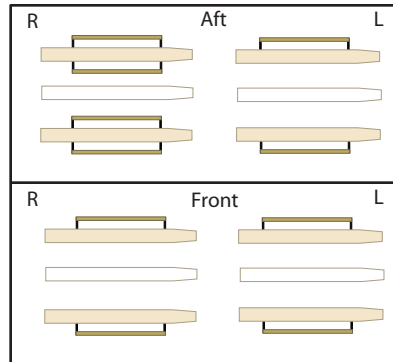

Aft

Front

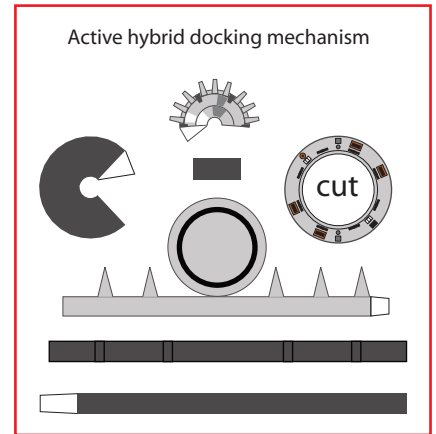
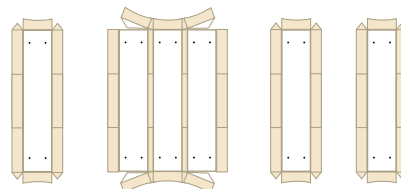
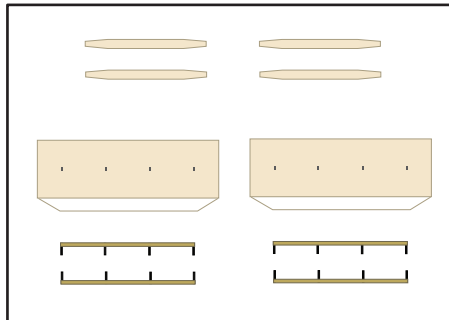

Active hybrid docking mechanism

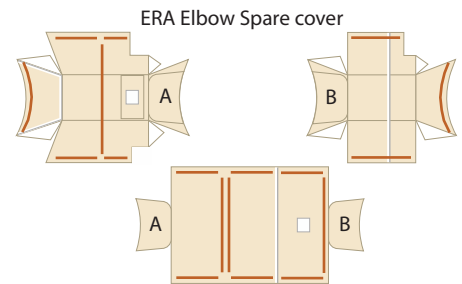

ERA Elbow Spare cover

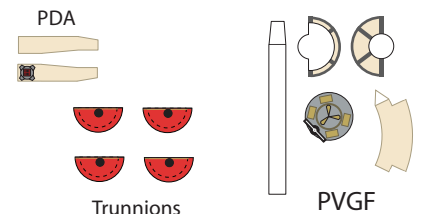
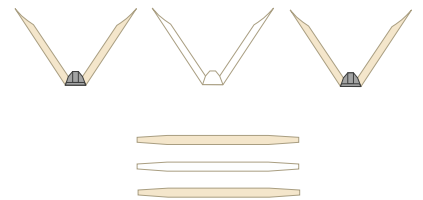

PDA

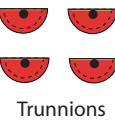

Trunnions

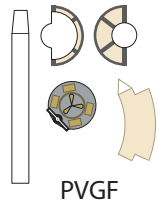

PVGF  
(Power & Video  
Grapple Fixture)

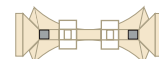
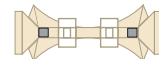

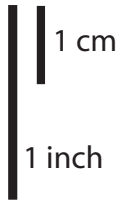

Print on Cardstock (90 lbs)  
 Mini Research Module-1 (MRM-1)  
 "RASSVET"



1:100 Scale  
 Sheet 2

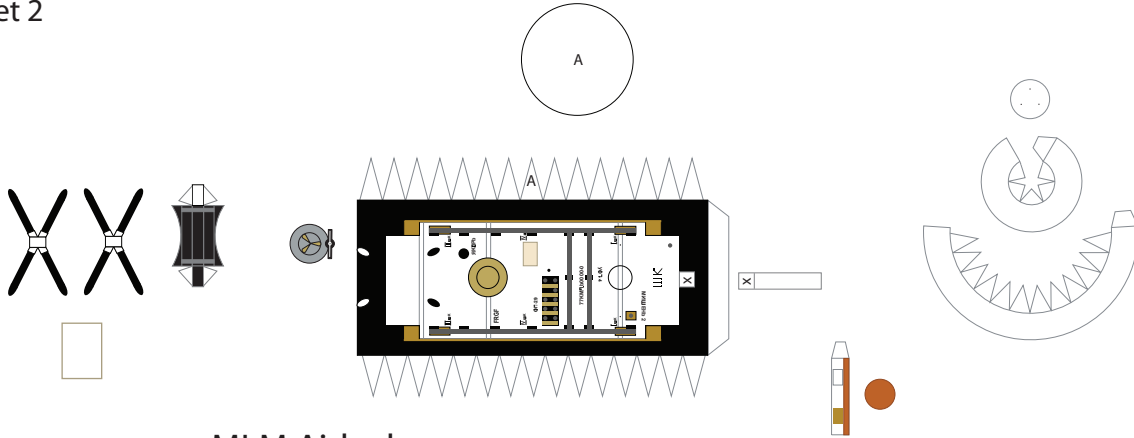

MLM Airlock

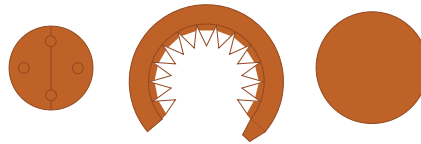

MLM Radiator

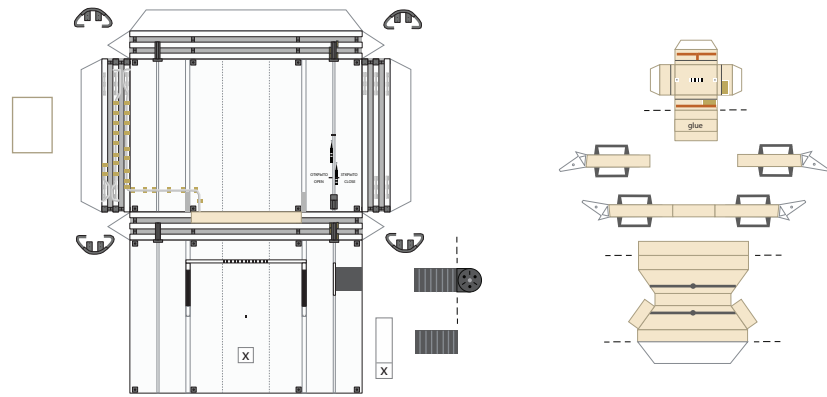

Portable Work Platform

