

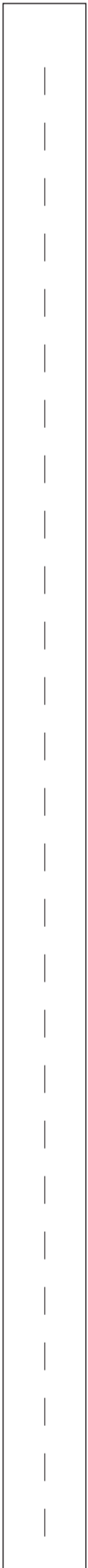

Print on Cardstock

# 1:144 External Tank general parts

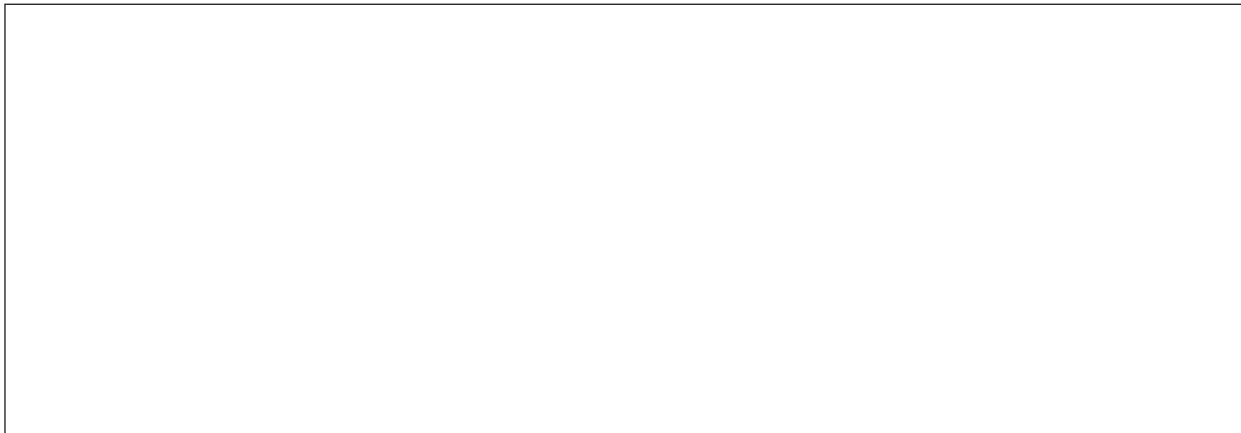

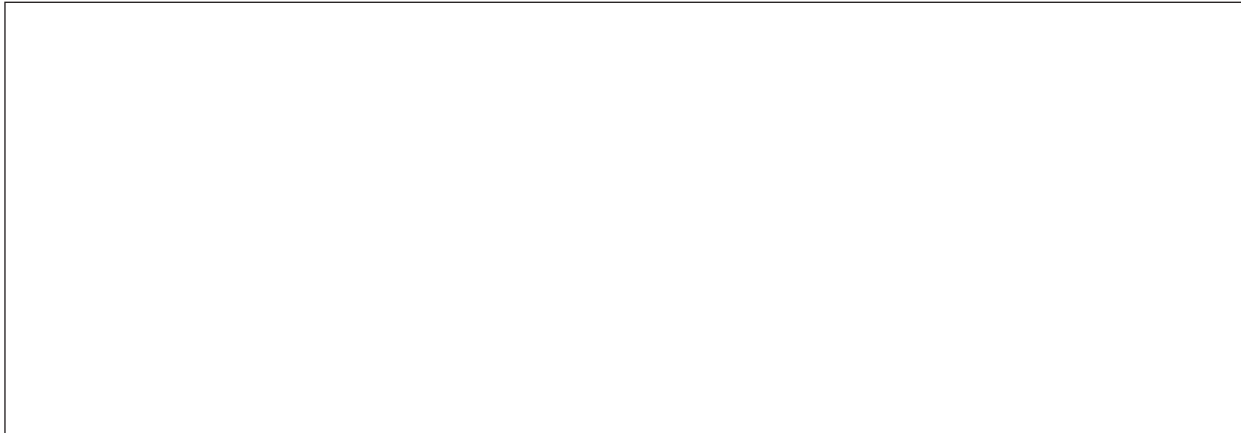
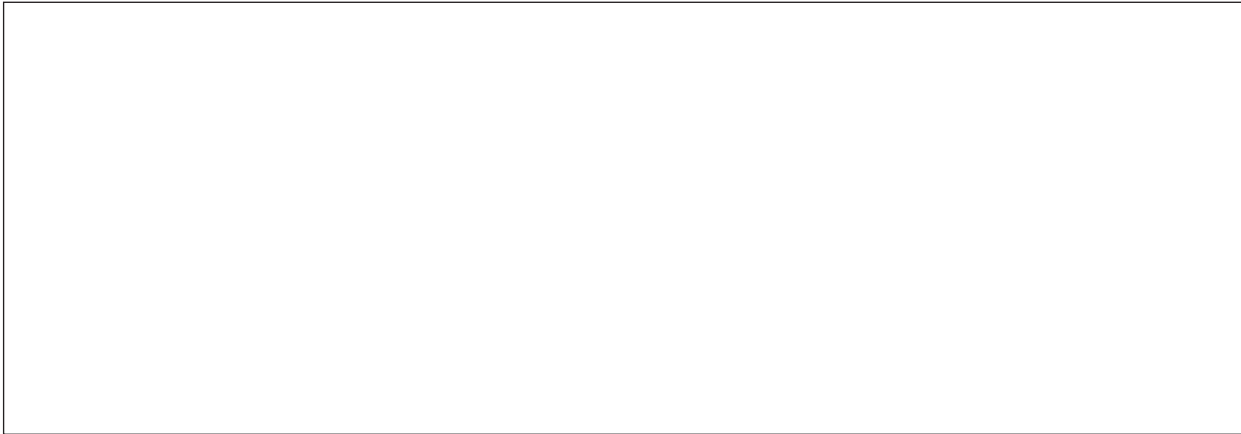

ET stacks5 (STS-134)  
ET-122

Print on Cardstock

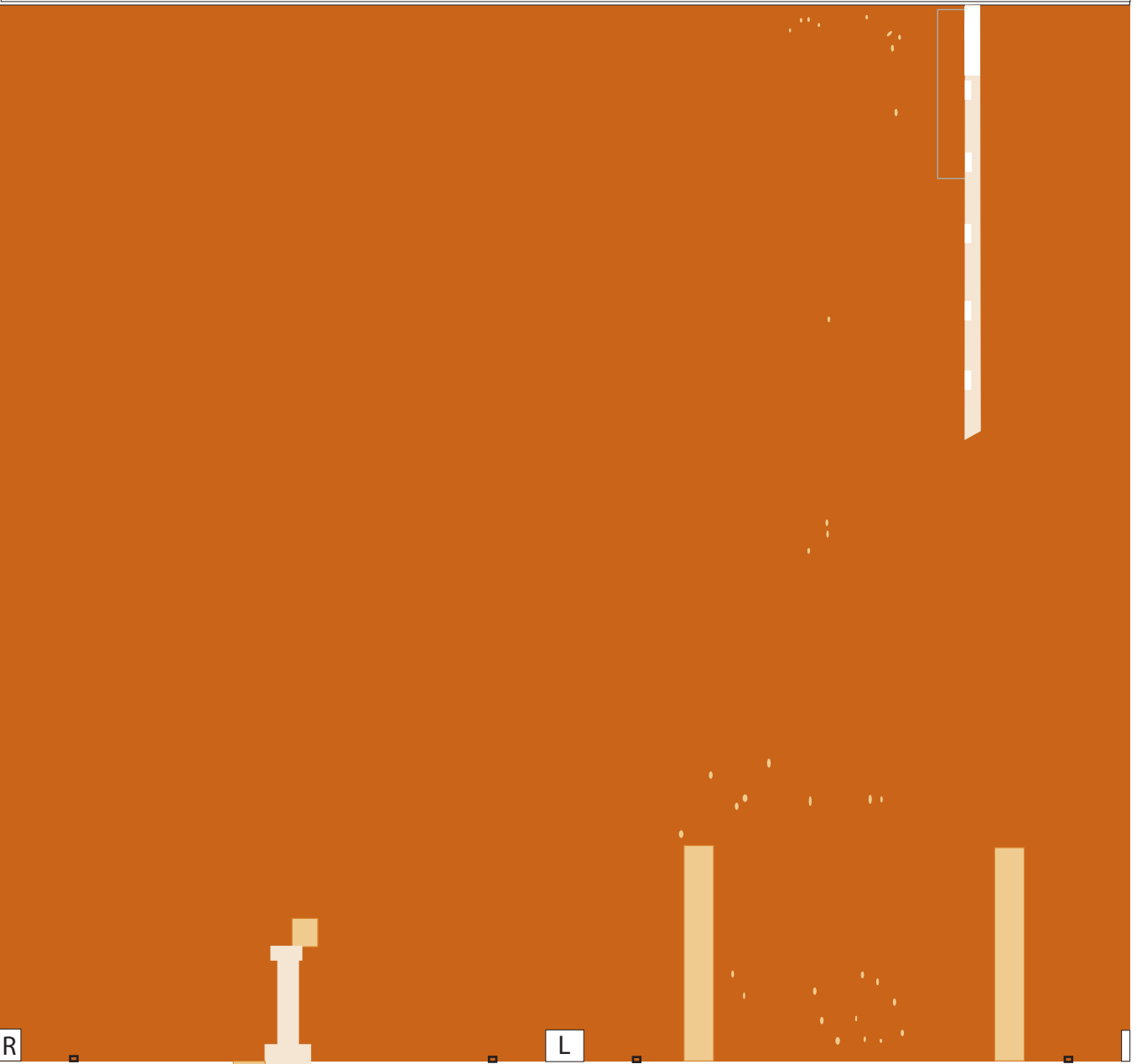
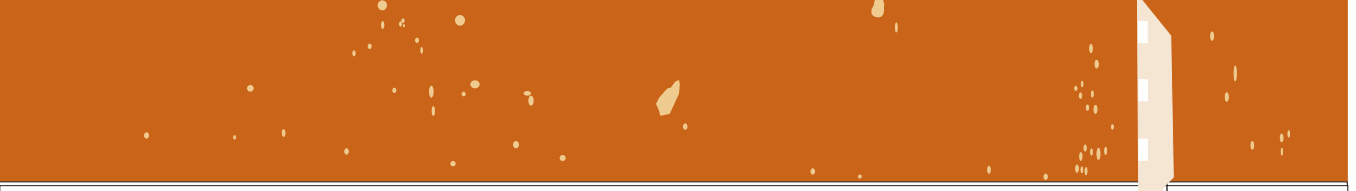

R

L



Print on Cardstock

ET stack5 (STS-134)

ET-122

N1

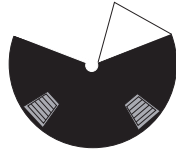

N2

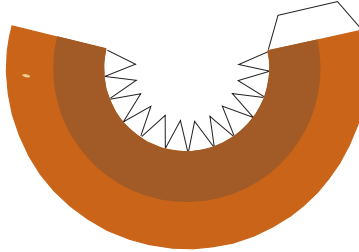

N3

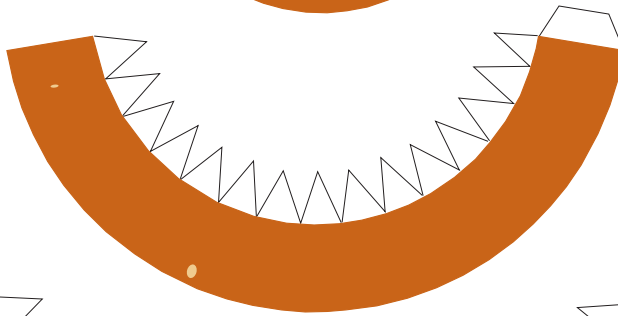

N4

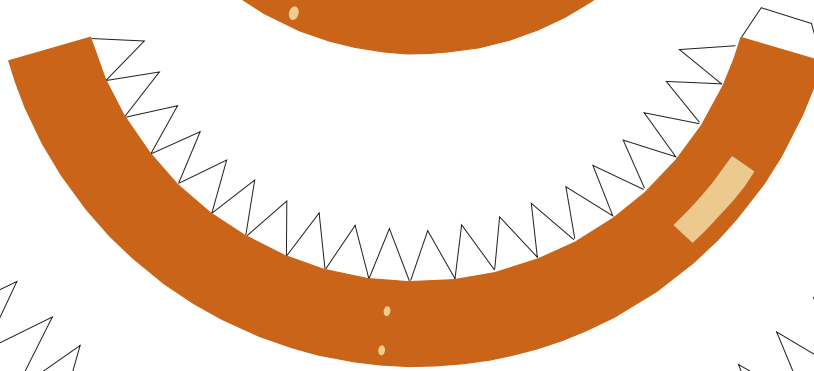

N5

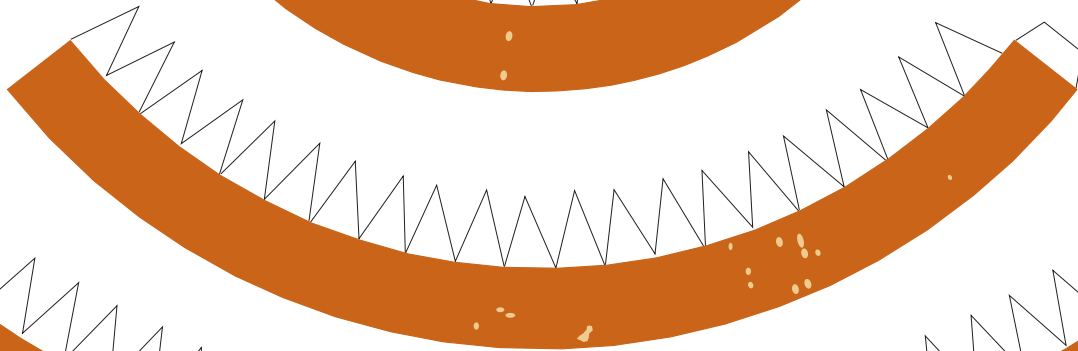

N6

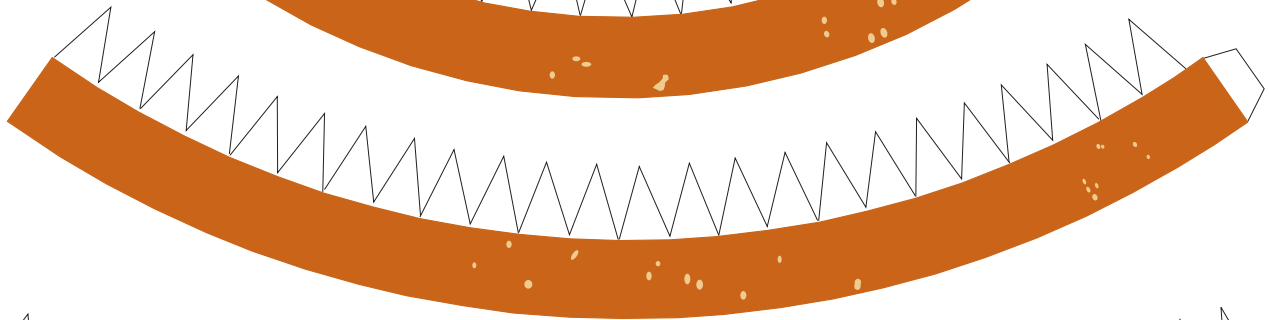

N7

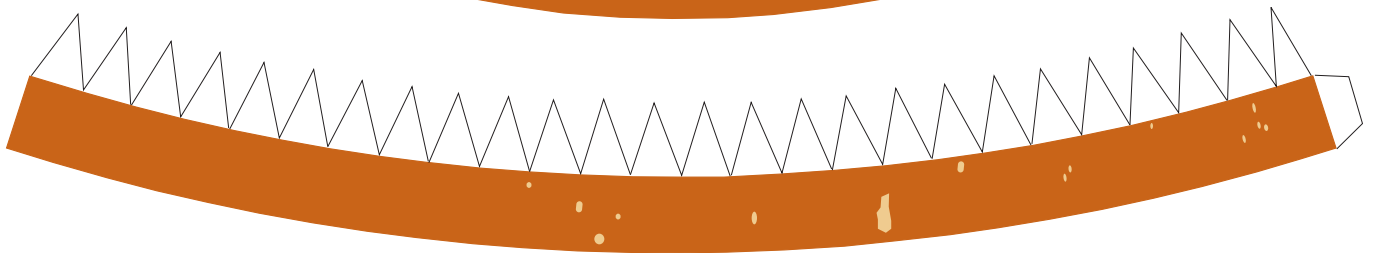



Print on Cardstock  
ET stack5 (STS-134)  
ET-122

©2011 Not for commercial use

B6

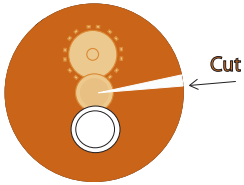

B6a

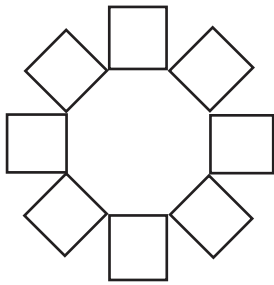

B5

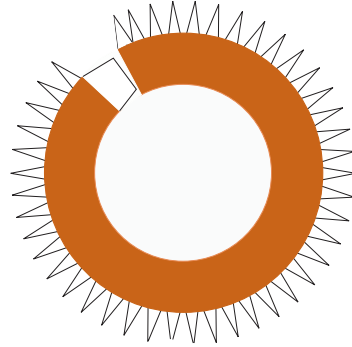

B4

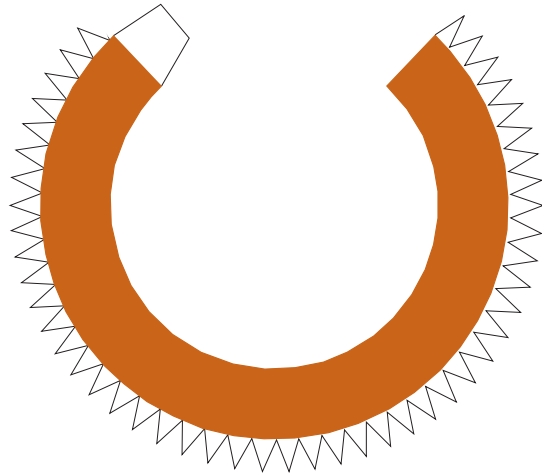

B3

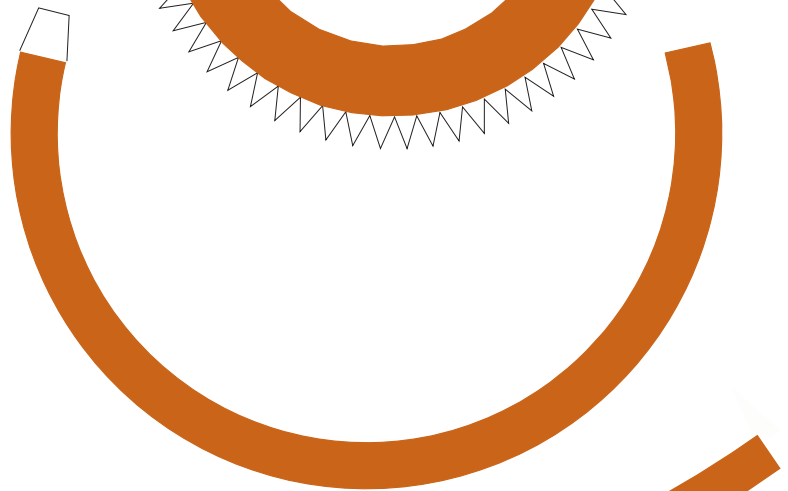

B2



B1

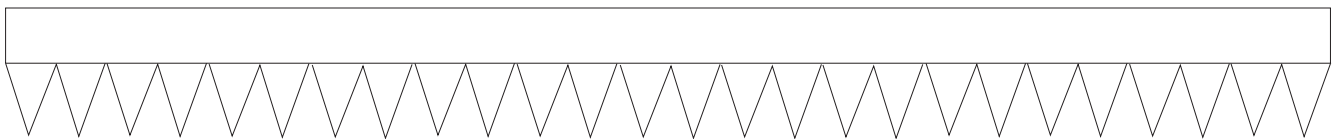



Print on Cardstock

# Intertank Stack 5 (STS-134) ET-122

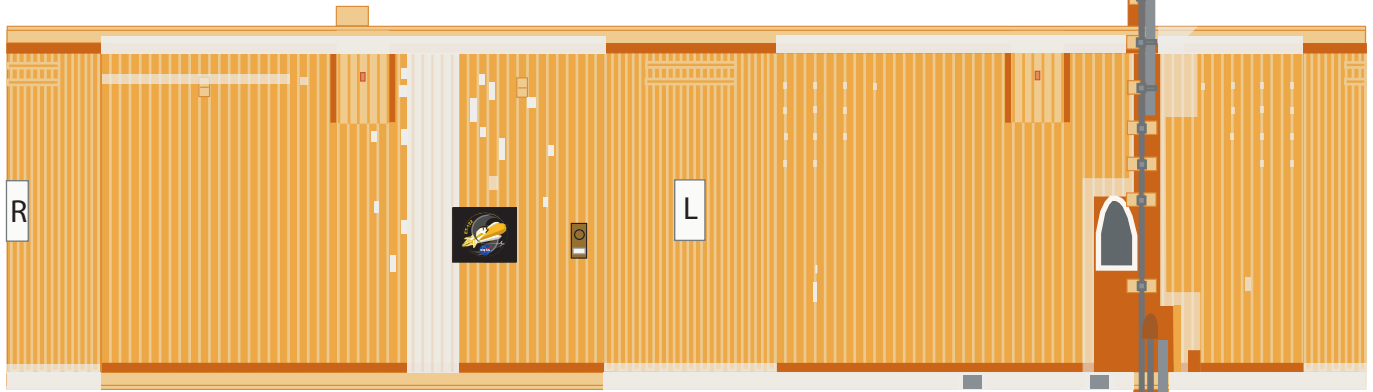

ET-122 logo

(Tank survived hurricane Katrina in 2005 and was repaired for flight)

\*Logo might be taken off for launch

T1



LO2



T2





Print on Cardstock

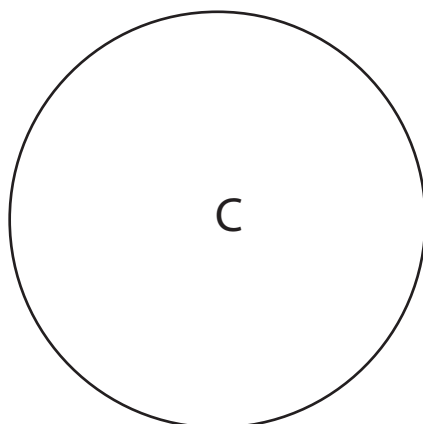
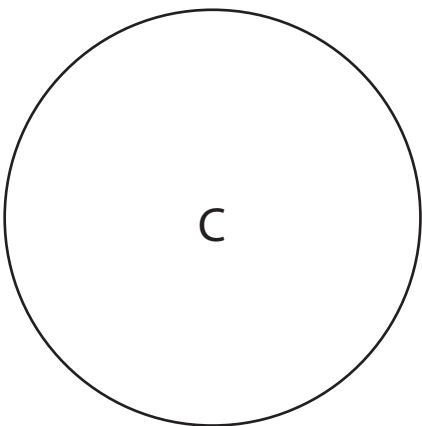
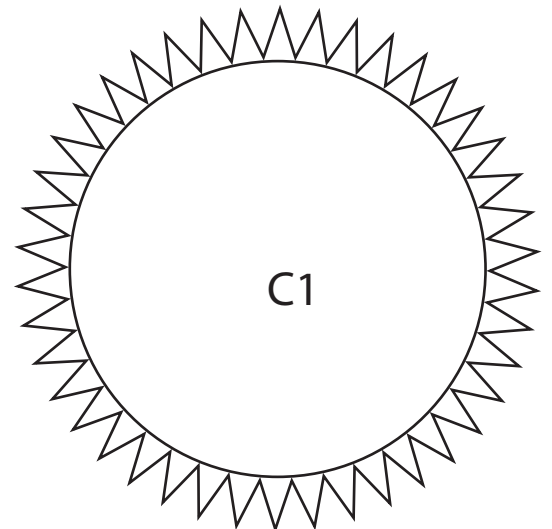
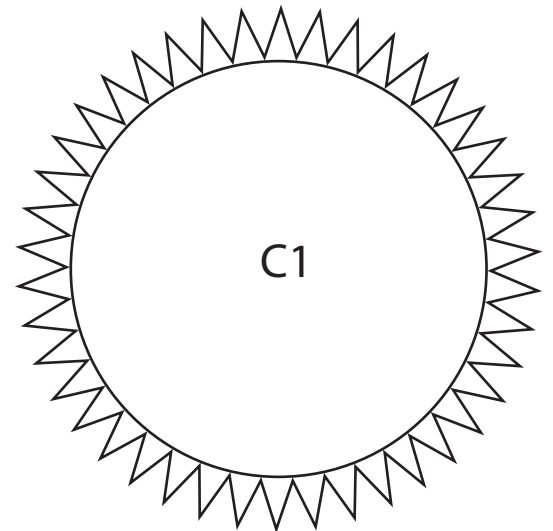
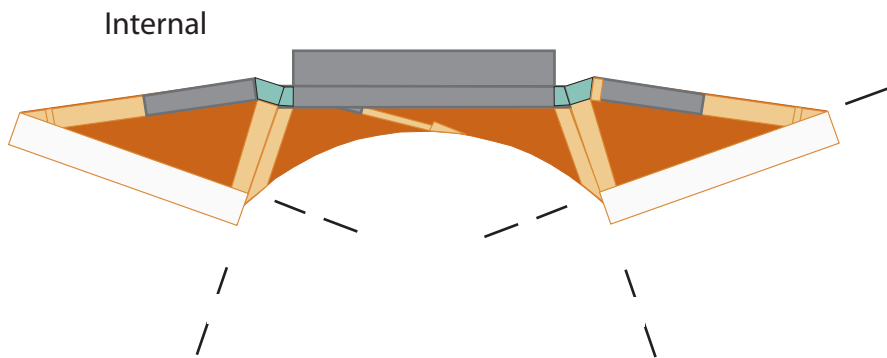
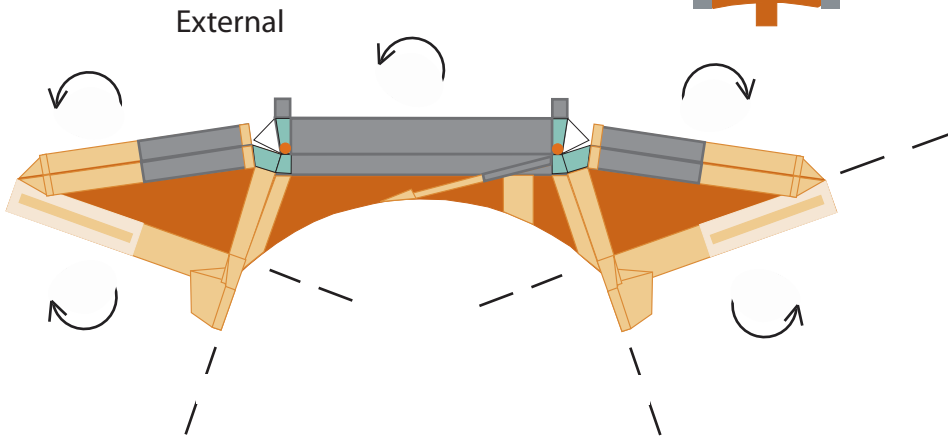
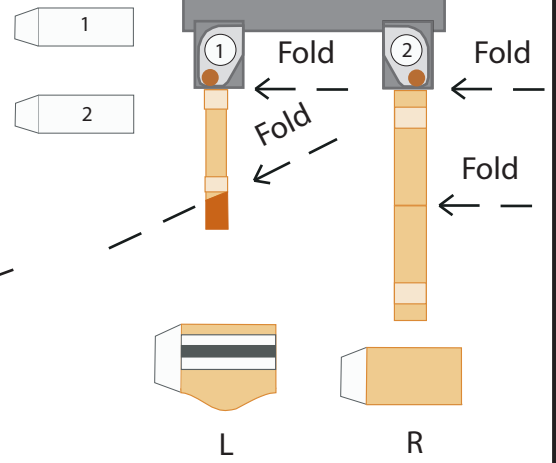
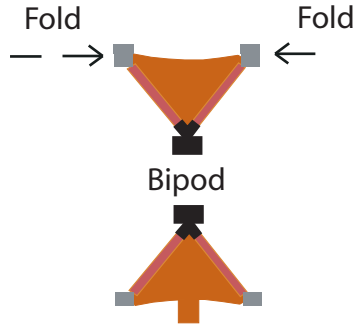



Important! Print on Paper only

ET stack5 (STS-134)  
ET-122

top



LO2 line

bottom