

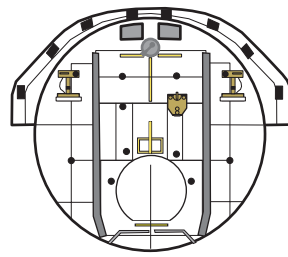

Print on Cardstock

1:144 STS-107 Payload bay

Sheet 1



Tunnel Support →

SpaceHab →

FREESTAR →

EDO Kit →

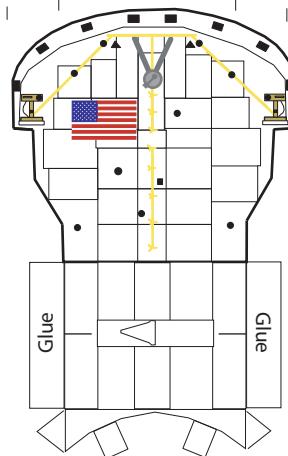
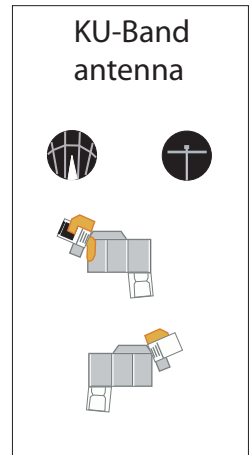
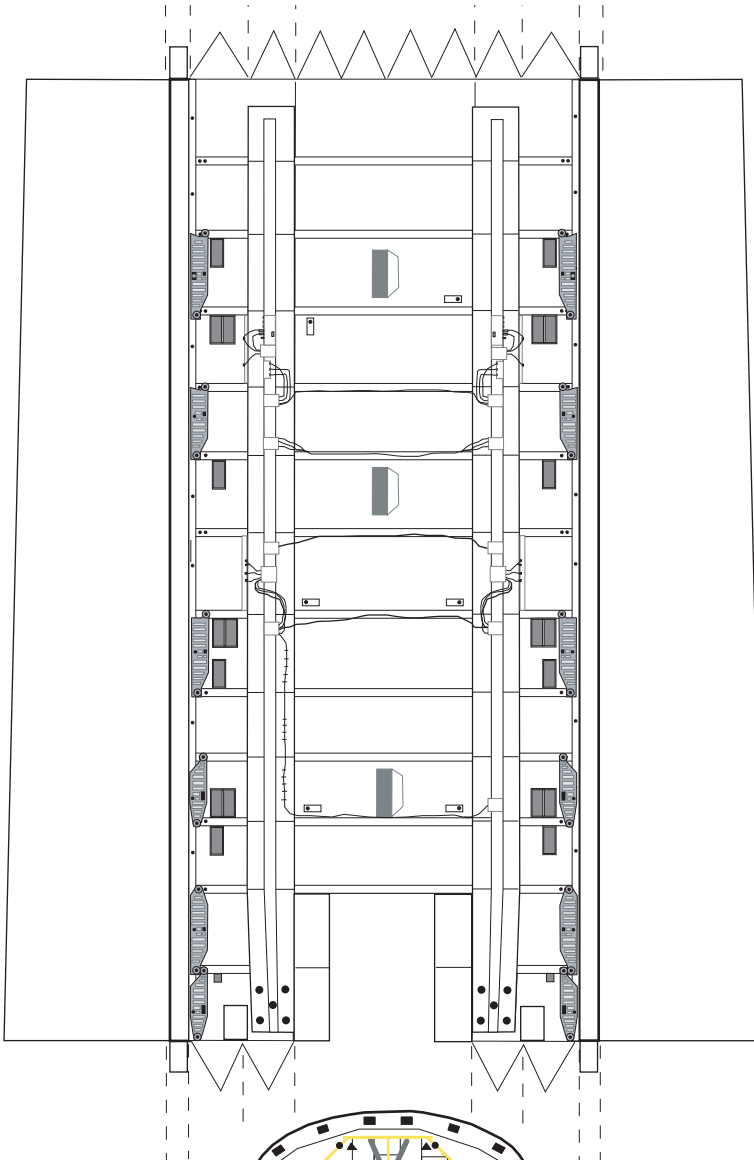



Transfer Tunnel

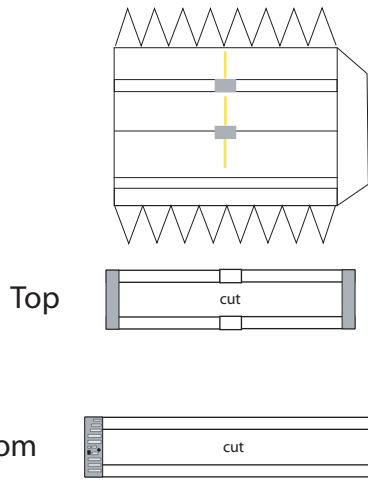

Top

Bottom

Print on Cardstock

1:144 STS-107 Payload bay

Sheet 2

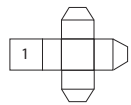
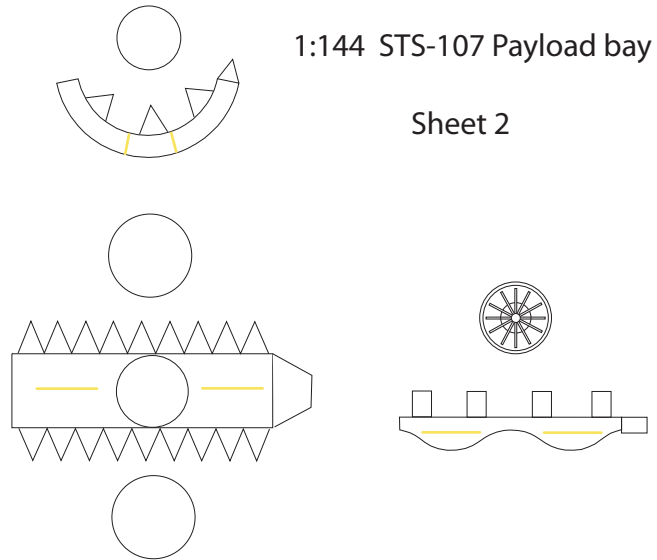

SpaceHab Double Module

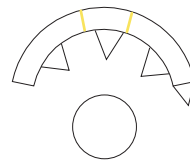
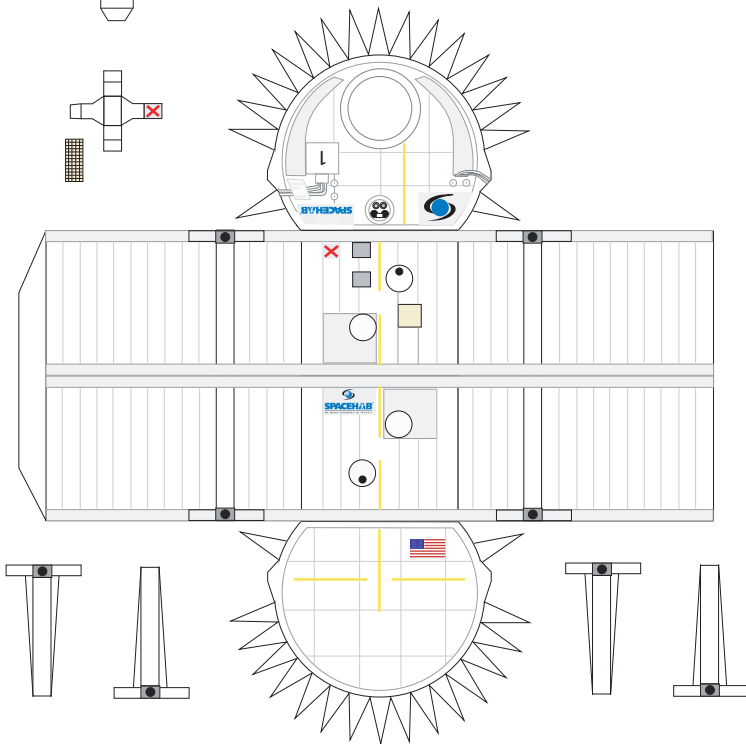

EDO Kit

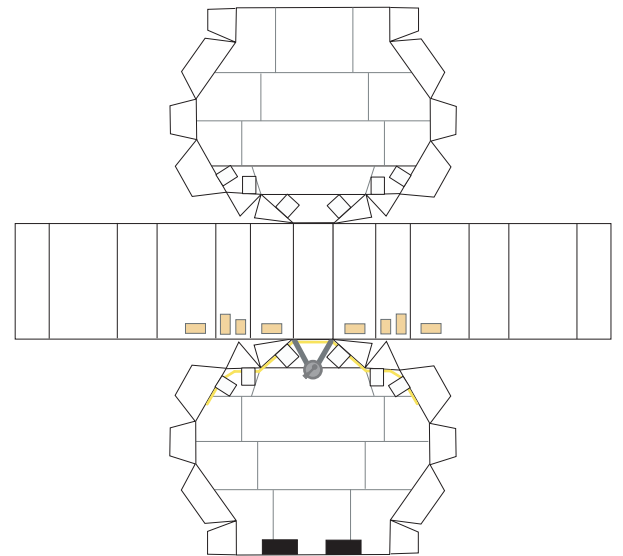

FREESTAR

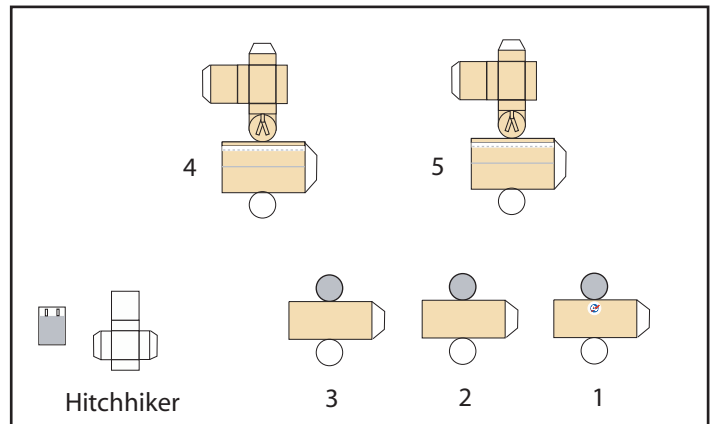
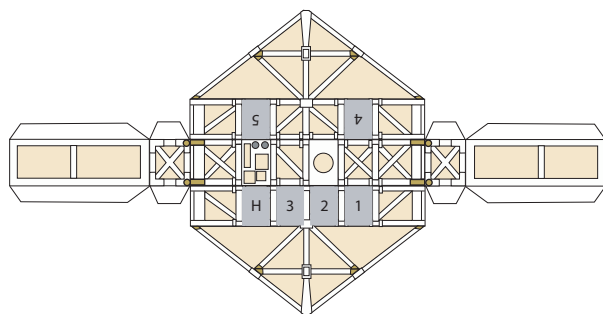



Rev. 1

Right side

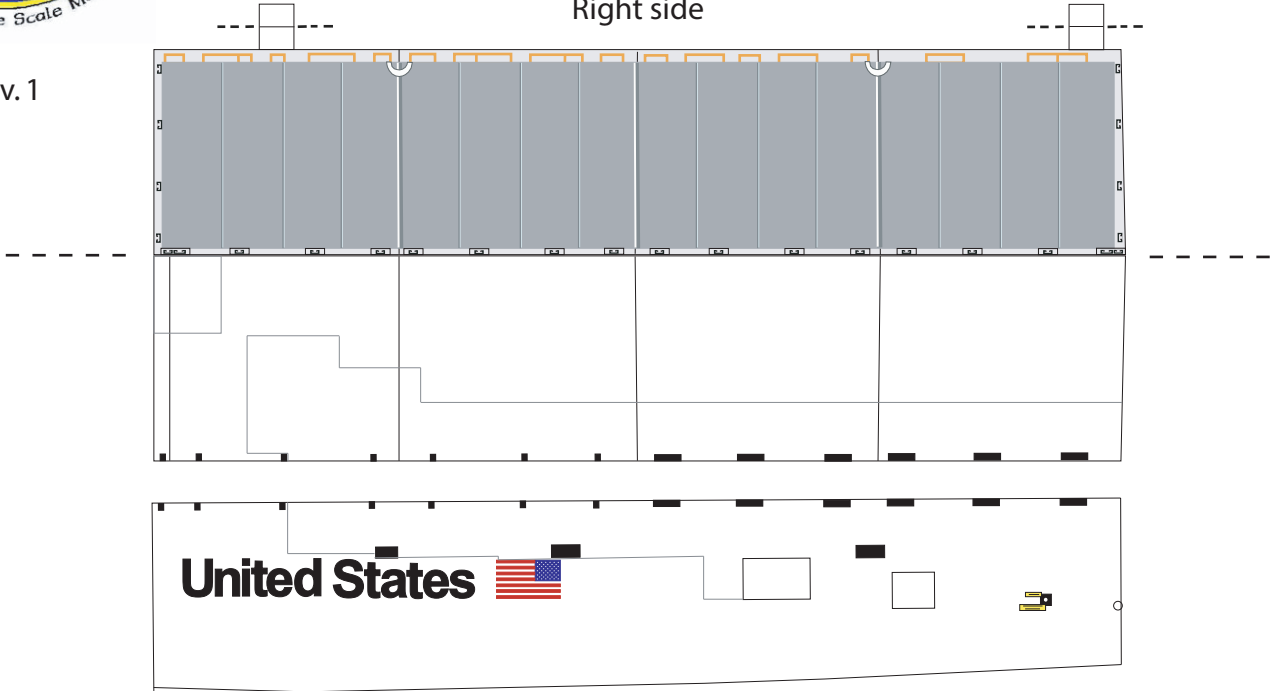

Left side

